

***Falcon HR
(Ontario)***

Traffic Safety Radar

OPERATOR'S MANUAL

Copyright © 2007-2015, Kustom Signals, Inc.
All Rights Reserved. Printed in U.S.A.

This publication may not be reproduced, stored in a retrieval system, or transmitted in whole or in part in any form or by any means electronic, mechanical, photocopying, recording, or otherwise without prior written permission of Kustom Signals, Inc., 9652 Loiret Blvd., Lenexa, KS 66219

Customer Service 1-800-835-0156 (620-431-2700)
Sales Department 1-800-4-KUSTOM (913-492-1400)

TABLE OF CONTENTS

1. INTRODUCTION.....	1.1
2. SPECIFICATIONS.....	2.1
2.0 General.....	2.1
2.1 Operational.....	2.3
3. INSPECTION AND INSTALLATION	3.1
3.0 Initial Inspection	3.1
3.1 Material Supplied.....	3.1
3.2 Cable Installation	3.2
3.3 Radar Installation.....	3.4
4. UNIT DESCRIPTION.....	4.1
4.0 Side View.....	4.1
4.1 Rear Panel.....	4.2
4.2 Remote Control.....	4.5
4.3 Mounting Pod (Optional).....	4.7
5. GENERAL THEORY of OPERATION.....	5.1
5.0 General.....	5.1
5.1 Microwave RF Emissions	5.4
6. TESTING PROCEDURES	6.1
6.0 General.....	6.1
6.1 Power-On.....	6.1
6.2 Automatic Self Test	6.1
6.3 Manual Test	6.2
6.4 Speedometer Verification	6.2
6.5 Minimum Patrol Speed Set	6.3
6.6 Moving Mode Test.....	6.4

7. OPERATION	7.1
7.0 Operating Modes.....	7.1
7.1 Operational Setup.....	7.1
7.2 Operation - Handheld.....	7.5
7.3 Operation - Dash Mounted.....	7.7
7.4 Moving Mode - Opposite Direction.....	7.9
7.5 Moving Mode - Same Direction	7.12
7.6 Speedometer Pulse Operation	7.13
7.7 Smart Patrol Search.....	7.14
7.8 Maintenance Mode.....	7.15
7.9 Test Screen Mode	7.15
8. INFLUENCES AND INTERFERENCE	8.1
8.0 Natural Influences	8.1
8.1 Man-Made Influences	8.2
8.2 Groundspeed	8.4
9. CARE OF THE FALCON HR	9.1
9.0 Routine Care	9.1
9.1 Equipment Repair/Return	9.2
9.2 Battery Disposal.....	9.3
10. CANADIAN CASE LAW.....	10.1
11. FCC INFORMATION.....	11.1
12. TROUBLESHOOTING	12.1
13. DIRECTIONAL OPERATIONAL SUPP	13.1
13.0 Directional Operation.....	13.1
13.1 Stationary Road Graphic.....	13.2
13.2 Moving Mode Road Graphic	13.2

13.3	Stationary Operation	13.3
13.4	Moving Mode Operation.....	13.6
13.5	Locking	13.9
14.	OPTIONS.....	14.1
14.0	Options Setup.....	14.1
14.1	Options Description	14.2
14.2	Options Examples	14.4
A.	PRINTER / DATALOGGER OPTIONS	A.1
B.	ATTESTATION OF CONFORMITY	B.1
B.1	Certification of Conformity.....	B.1
B.2	AS/NZ Certification of Conformity	B.2

1. INTRODUCTION

The Kustom Signals Falcon HR directional radar system comes from a long-standing commitment to the law enforcement community to provide quality, state-of-the-art speed measuring equipment. The Falcon HR offers a wide range of features on this moving/stationary handheld K-Band radar system, yet allows easy operation and simple one-button mode changes.

Falcon HR units have the newest directional features; **Dual Channel Microwave** antenna and **Directional Digital Signal Processing (DSP)**. This allows Kustom Signals to add features such as same direction with automatic add or subtract difference speed, fastest vehicle detection in all modes, TruTrak with **Automatic Mode Switching (AMS)**, **Smart Patrol Search (SPS)** and stationary modes that allow the operator to select approaching only, receding only, or all targets identification. With these features, the officer can better identify the offending vehicle and eliminate much of the confusion of high traffic environments.

All these features and performance standards are packed into this small, lightweight, corded or battery-operated unit, providing the most flexibility for the operator.

The Falcon HR sets a new standard for low current operation. This will be appreciated by long run times when battery operated, or low draw on the already heavily taxed patrol vehicle's power source.

2. SPECIFICATIONS

2.0 GENERAL

Type:	One-piece, Directional Moving / Stationary, Doppler radar system.
Frequency:	K-Band 24.125 GHz \pm 100 MHz
System Accuracy:	Stationary: \pm 1km/h Moving: +1/-2 km/h
Operating Voltage:	Corded: 10.0 to 16.5 VDC, 300 mA max.

The Falcon HR will operate normally and not display a low voltage alert to at least 10.0 VDC. Typically it will continue to operate even when the external battery voltage drops substantially below the specified 10.0 VDC.

Cordless: 6.5 to 9.0 VDC
7.2 VDC nominal NiMH

Low Voltage Threshold:	Corded: Typically 9.0 VDC Cordless: Approximately 6.5 VDC
------------------------	--

SECTION 2 - SPECIFICATIONS

Nominal Power
Requirements:

	Voltage (VDC)	Current (mA)
No target present:	13.6	140
With target present: Audio = Max Backlight = Off	13.6	230
With target present: Audio = Max Backlight = On	13.6	240
Standby (HOLD): After 30 seconds	13.6	60 24

Reverse Voltage Protection: Diode protection. No damage if supply leads reversed.

Electronic Components: 100% solid state; integrated circuits, and Digital Signal Processor.

Operating Temperature: -30°C to +60°C
90% relative humidity at 37°C, non-condensing.

Dimensions:

Unit:

Height:	9.04 cm
Width:	7.62 cm
Depth:	13.58 cm
Weight:	.59 kg

Handle:

Height:	14.6 cm
Width:	5.51 cm
Depth:	9.16 cm
Weight:	
Cordless:	.37 kg
Corded:	.17 kg

2.1 OPERATIONAL

Speed Processor:	Digital Signal Processing (DSP) performs all functions and signal analysis.
Manual Test:	All display segments checked; checks internal calibration and performs a cross check of quartz crystals for accuracy.
Automatic self-test:	Comparison of quartz crystals done periodically (5 minutes maximum), upon every mode change and at the time of lock. "Err" displayed if an error is found.
Lock Time:	Instantaneous.
Patrol window:	Displays Doppler patrol speed.
Target window:	Displays truncated target speed.
Lock/Fast Window:	Displays locked target speed or fastest vehicle in Fast mode.
Display Type:	Static Liquid Crystal Display (LCD).
Back Lighting:	Fiberoptic, single Light Emitting Diode (LED).
Automatic Clear:	All locked displays are cleared when mode of operation changes.

SECTION 2 - SPECIFICATIONS

Speed Range:	Meets IACP/NHTSA specifications for target sensitivity. Stationary: 10 dB from 56 to 144 km/h; 5 dB from 96 to 144 km/h. Moving (Opposite Dir.): 10 dB from 64 to 144 km/h; 5 dB from 96 to 144 km/h. Moving (Same Dir.): 10 dB from 8 to 40 km/h.
Stationary:	Spec: 16 to 330 km/h. Typical: 9 to 334 km/h.
Patrol:	Spec: 16 to 160 km/h Typical: 9 to 193 km/h.

SECTION 2 - SPECIFICATIONS

Target:	
Opposite Dir.:	Target minimum (Patrol < 64 km/h): Spec: 16 km/h Typical: 14 km/h Target minimum Patrol > 64 km/h: Spec: 32 km/h Target maximum: (Combined patrol and target speeds): Spec: 330 km/h Typical: (334 km/h.
Same Dir.:	Minimum difference speed: Spec: 8 km/h Typical: 5 km/h. Maximum difference: 0.65 x Patrol Speed.
Indicators:	
Stationary:	“TARGET” window displayed.
Moving:	“PATROL” and “TARGET” both displayed in window.
Low Battery:	(Warning) Flashing “BATT” displayed and an audio warning tone sounds every 2 minutes when internal voltage falls below approximately 6.6 VDC. Approximately 30 minutes of transmitter operation remains.
Low Voltage:	(Error) Steady “BATT” displayed when internal voltage falls below approximately 6.0 VDC. The transmitter is disabled, but locked speeds will remain. At approximately 5.4 VDC, the Falcon HR shuts itself off.

SECTION 2 - SPECIFICATIONS

Radio Frequency Interference:	“rFi” displayed in the target window during strong radio frequency interference. Active speed displays are blanked during this condition. Locked speeds will remain.
Error:	“Err” displayed when an internal error in the operating system is detected. Active speed displays will blank. Locked speeds will remain.
Hold:	“HOLD” is displayed when the system is not transmitting. Controlled by the trigger in handheld mode or remote control in mounted mode.
Lock:	“LOCK” displayed and flashing indicating locked target speed.
Fastest:	“FAST” displayed when fastest mode (stationary or moving) selected. Indicator flashes in locked fastest mode.
Test:	Indicator is on when displaying Test screens.
Km/h:	Indicator is on when the unit is displaying speeds in km/h.
Road Graphic:	These indicators are used to show the mode of operation and target direction.



SECTION 2 - SPECIFICATIONS

Fastest Graphic: These indicators are used to indicate the direction of the fastest speed.

Approaching Receding



Microwave Freq: 24.125 GHz.

Beam Width:
(Horizontal) $12^\circ \pm 1^\circ$.

Polarization: Linear.

Power Density: Less than 1 mW/cm^2 at aperture.

Source Power: 8 mW max.

3. INSPECTION AND INSTALLATION

3.0 INITIAL INSPECTION

Before installing your Falcon HR, please take a moment to carefully inspect the shipping carton for damage. Contact the shipping carrier at once if you notice any damage.

Remove the unit from the shipping carton and check the packing list against your original purchase order. If the shipment is incomplete or parts are missing, please contact Kustom Signals Customer Service Department at 1-800-835-0156, or (620) 431-2700.

3.1 MATERIALS SUPPLIED

The following equipment is normally included:

- Antenna/Display Unit
- Operator's Manual - CD
- Corded Handle

Moving Mode Version

- IR Remote Control
- Dash Mount
- Speedometer Pulse Cable

OPTIONAL

- Fastest Vehicle Mode Feature
- Same Direction Mode Feature
- Dash Mounting Pod
- Wired Remote Control
- Battery Handle
- 110V Trickle Charger
- Fast Charger with 12VDC Charging Cord
- AC Adapter for Fast Charger (110V or 220V)
- Heavy Duty Carrying Case
- Auxiliary Power Receptacle Cable

3.2 CABLE INSTALLATION

3.2.1 AUXILIARY POWER RECEPTACLE

Cigarette lighter receptacles have been the traditional source of power for traffic radar over the years. In newer vehicles, it is possible that poor grounding of this receptacle and electrical noise from various sources can combine to create an unacceptably high level of electronic interference.

This interference can affect the radar's performance in several ways: decreased range, no target speeds being displayed, or abnormal tones or noise in the audio. An auxiliary power receptacle and cable, which mounts under the dashboard and wires directly to the battery, is available from Kustom, part number 155-2127-00.

1. Mount the receptacle in the desired location using the hardware provided.
2. Connect the black wire to the receptacle's mounting bracket. Connect the white wire (with Faston terminal) to the rear plug of the receptacle. Route the cable through the firewall and up to the battery.
3. Connect the white wire of the power cable to the battery (+) positive terminal and the black wire to the (-) negative terminal.
4. The auxiliary power receptacle is supplied with a 2 amp fuse to protect the wiring and battery should the cable become shorted.

3.2.2 SPEEDOMETER PULSE CABLE

Installing the provided cable to the vehicle's speed sensor (VSS) provides a signal to the Falcon HR for Kustom Signals patented Tru-Trak assisted patrol speed search feature. This feature virtually eliminates the problems of patrol shadowing and patrol combining. This signal also allows the unit to automatically switch between moving and stationary modes as the vehicle's movement is sensed.

1. The speedometer pulse cable has a connector at one end, which plugs into the mounting pod of the Falcon HR.
2. The red wire (inner conductor) of the cable will be connected to the patrol vehicle's electrical speedometer input cable using the splice connector provided. Due to the vast amount of models, makes and years of vehicles, we have moved access to specific vehicle diagrams online where information can be better maintained and distributed.

Installation details can be accessed at:

<http://www.kustomsignals.com>

(Products→ Radar→ Model→ Speedometer Installation)

If your vehicle year, make and/or model is not listed or you need hard copies, please contact Kustom's Customer Service Department at (800) 835-0156. If you are outside of the US and Canada, please call (620) 431-2700.

NOTE: Only the inner conductor of the speedometer pulse cable is used. The outer shield is not connected.

3. The speedometer interface will be set up later, in Sec. 6.4.

3.3 RADAR INSTALLATION

1. The Falcon HR is shipped with the handle (corded or cordless) attached. With the handle attached, the user can operate the unit in the handheld or dash mounted mode. In the handheld configuration, the radar operates only in the stationary mode when the unit is removed from the mount. In this situation, the transmitter is only active when the trigger is pulled.
2. For dash mounting, the unit can operate with the handle attached placed in the dash mount, or with the pod attached and mounted on the pod bracket. When the unit with a handle is placed in the dash mount, the trigger is inoperable and the remote control is used to control the unit. To attach the pod, remove the handle by pressing the blue release button (latch) on the bottom of the indicator and sliding the handle backwards. Locate the dash bracket and mounting pod. Fasten the mounting pod to the dash bracket, and then slide the Falcon HR onto the pod by placing it in front of the pod and sliding backwards. The mounting pod may be turned 90° on the mount and the Falcon HR slid onto it from the side.
3. Position the radar and mount in a suitable location on the dash within view of the driver and in a safety zone during airbag deployment. Normally this will be to the left or right of the steering wheel as space permits.
4. Connect the Falcon HR's power cable to the proper power source. See Section 3.2.1.

SECTION 3 - INSPECTION AND INSTALLATION

5. Momentarily press the PWR switch on the rear panel of the Falcon HR. (Refer to Section 4.1 for location and function of the switches.) The Falcon HR will proceed through an indicator test, internal test and several other reliability tests. Select the Stationary “ALL” mode of operation by pressing the MODE switch, if required. (If “PATROL” is displayed, press the MODE switch.) Only “TARGET” will be displayed in the stationary mode with the patrol window indicating “ALL”, “APr”, or “rEc”.

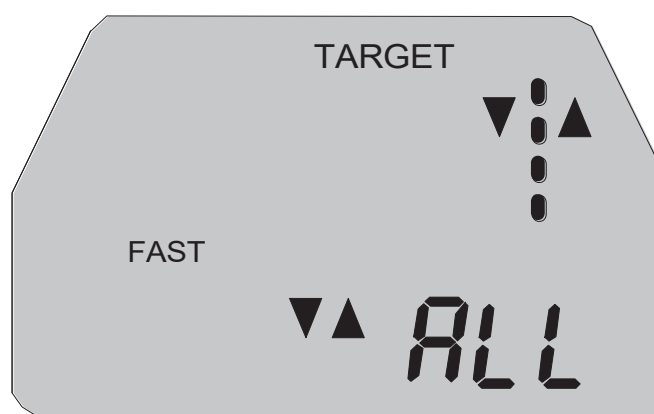

6. Momentarily press the AUD (audio) switch. The TARGET window will display “Aud” and a number from 1 to 5 indicating the audio level. With “Aud” displayed, press the RNG (range) switch until level 3 or 4 is displayed. Also, with “Aud” displayed, press the MODE switch, which will unquiet the audio.
7. Start the patrol vehicle and position the A/C-heater fan to a mid-range speed. Move the Falcon HR left or right of its initial location and listen for any raspy sound (fan interference) in the audio. Position the Falcon HR to minimize the amount of interference.

CAUTION: Review the airbag warning statement shown in this manual before securing the dash bracket.

SECTION 3 - INSPECTION AND INSTALLATION

8. When a suitable location is found, secure the dash bracket to the windshield using the suction cups and Velcro.

9. Position of the antenna:

Moving: Aim the antenna parallel to the ground and straight down the roadway.

Stationary: Unit may be operated on the mount or handheld to achieve maximum performance and pointed directly toward the vehicles being monitored.

4. UNIT DESCRIPTION

4.0 SIDE VIEW

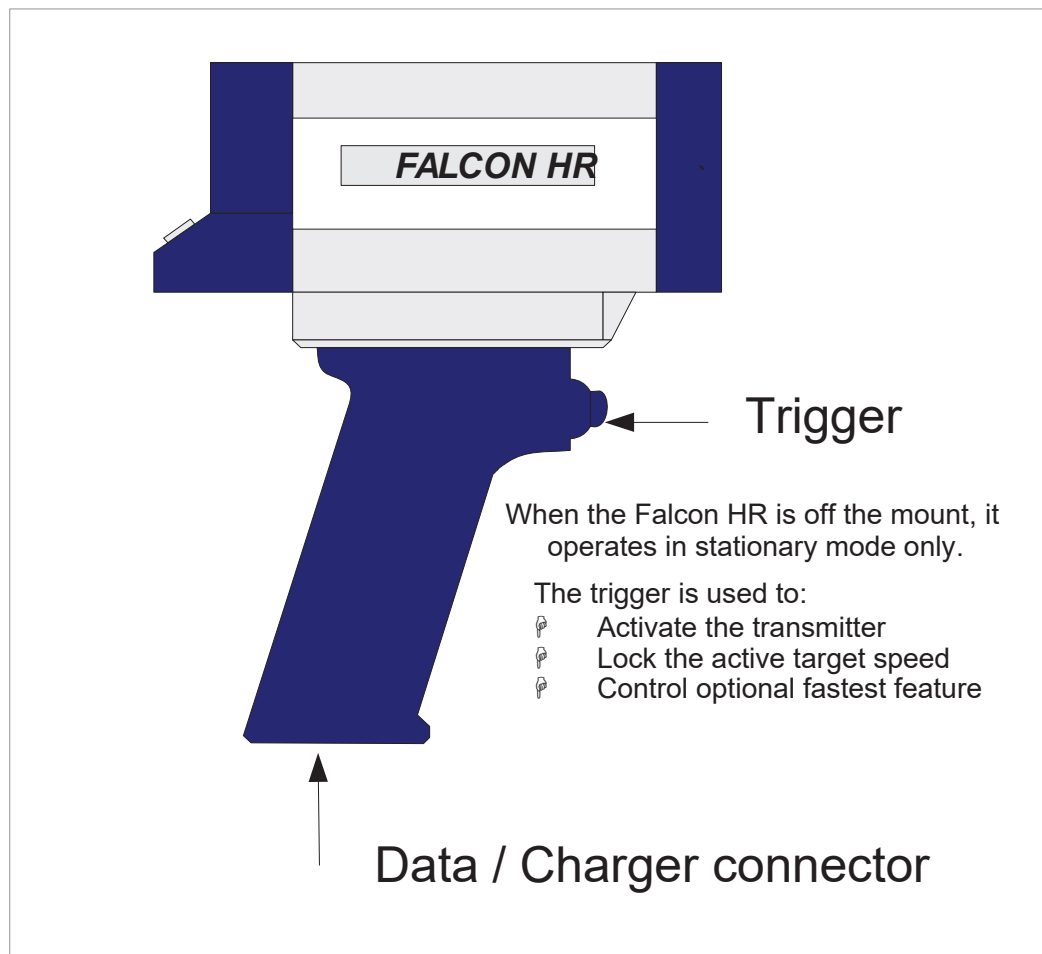

NOTE: The Falcon HR can connect to video systems, remote control systems, or have the operating software updated through the data connector.

4.1 REAR PANEL

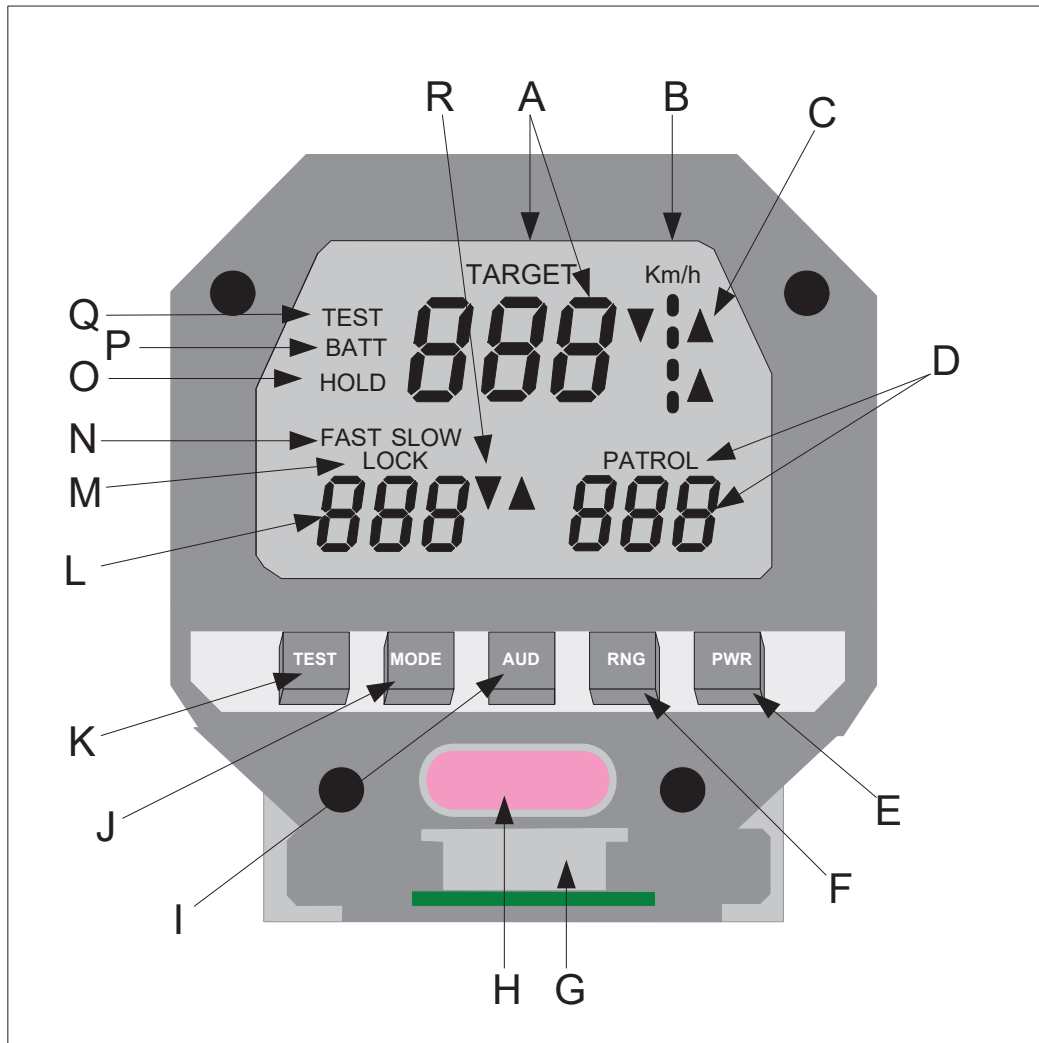

A. TARGET

Displays target vehicle speeds in stationary and moving modes.

B. Km/h

Indicates when the speed readings are in kilometers per hour, km/h.

SECTION 4 - UNIT DESCRIPTION

C. Road Graphic	Indicates Mode of operation: moving or stationary. Indicates target direction: approaching or receding.
D. PATROL	Displays the patrol vehicle speed. Displays the stationary directional modes: Approaching only “APr”, Receding only, “rEc”, or All “ALL”.
E. PWR	Turns the unit on or off.
F. RNG (Range)	Puts the unit in the range set mode. Secondary function is the increment (up) control.
G. Latch	Press to unlatch radar from handle.
H. IR Detector	Receiver for the IR remote control.
I. AUD (Audio)	Puts the unit in the audio set mode. Secondary function is the decrement (down) control.
J. MODE	Rotates the unit through the four modes of operation. <ol style="list-style-type: none">1. Moving Mode.2. Stationary “ALL”.3. Stationary Approaching only “APr”.4. Stationary Receding only “rEc”.
K. TEST	Initiates the test mode, used to test the internal accuracy and to light all indicators. Also used to access the Backlight feature. See Section 7.1.7.

SECTION 4 - UNIT DESCRIPTION

L. FAST/LOCK Display	Displays fastest or locked vehicle speeds.
M. LOCK	Indicates the FAST/LOCK display is showing a Locked speed.
N. FAST	Indicates the unit is in fastest mode and that the fastest vehicle speed is displayed in the FAST/LOCK window.
O. HOLD	Indicates the radar transmitter is turned off.
P. BATT	Indicates when the battery or external power source is below the minimum operating voltage.
Q. TEST	Test indicator.
R. Fastest Indicators	Indicates the direction of travel of the fastest vehicle.

4.2 REMOTE CONTROL

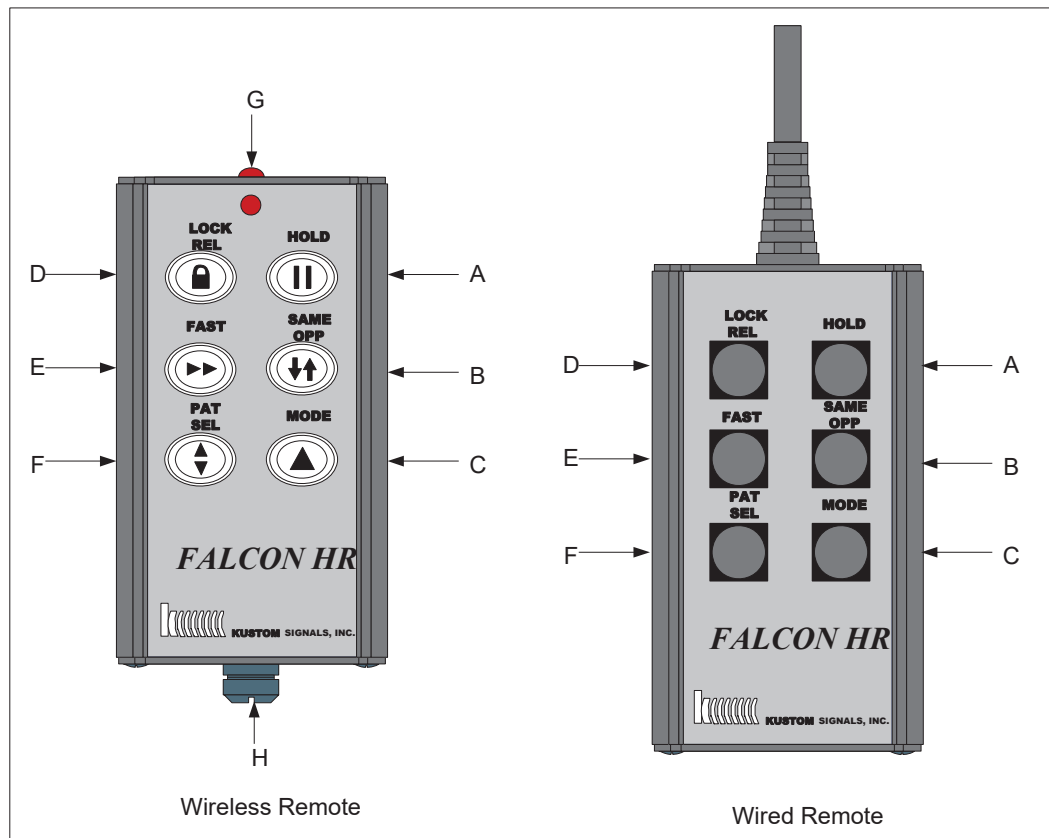

When the Falcon HR has a handle attached and is placed in the mount, certain functions can be controlled with the Wireless/Infrared (IR) remote. If the unit is attached to the optional pod, a wired or IR remote can be used.

SECTION 4 - UNIT DESCRIPTION

The remote controls the following functions:

- | | |
|--|--|
| A. HOLD | Turns the radar transmitter on and off. |
| B. SAME/OPP | In moving mode, selects either the same or opposite direction. In stationary mode this button toggles between approaching only and receding only modes. |
| C. MODE | Rotates through the four modes of operation. <ol style="list-style-type: none">1. Moving Mode.2. Stationary ALL.3. Stationary Approaching only.4. Stationary Receding only. |
| D. LOCK/REL | Alternately Locks and Releases the target and patrol speeds. |
| E. FAST | Turns fastest vehicle mode on or off. |
| <div style="border: 2px solid black; padding: 5px;">NOTE: Fastest can be operated one of two ways. See Sec. 14, Options, for details.</div> | |
| F. PAT SEL
(Patrol Select) | Blanks or recalls a locked patrol speed. Also used for setting minimum patrol speeds and synchronizing the speedometer input. |
| G. IR Transmitter | Two IR transmitter LEDs. |
| H. Screw Release | Screw fastener to allow access into the battery compartment. |

4.3 MOUNTING POD (OPTIONAL)

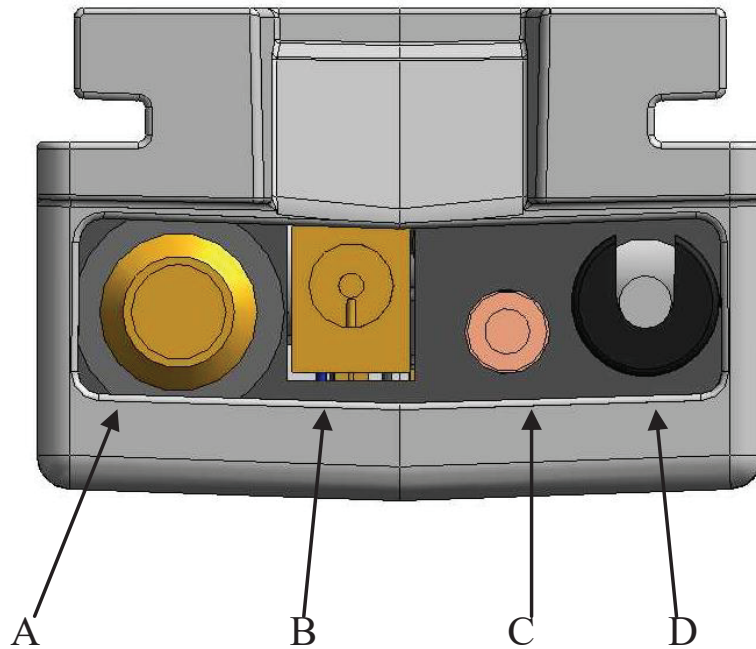

- | | |
|----------------------|---|
| A. Data Port | RS232 I/O port provides information to video systems or for updating operating software. All operations of the Falcon HR can be controlled via this port. |
| B. Speedometer Input | Accepts speedometer cable connector. |
| C. Remote Control | Accepts the wired remote control jack. |
| D. Power Cable | Permanently attached to the pod. |

5. GENERAL THEORY OF OPERATION

5.0 GENERAL

The Falcon HR moving radar system transmits a K-Band radio frequency in compliance with the Federal Communications Commission (FCC) regulations.

Antenna Description: The Falcon HR employs a Doppler RF Transceiver Module (integrated antenna element and electronic transceiver) that is assembled into the front-end of the Falcon HR. The antenna element is a Microstrip Patch Antenna array (MSPA). The Transceiver Module antenna element is not a phased array. The MSPA antenna is fabricated with microstrip patch elements printed onto the top surface of a flat substrate. The bottom surface of the substrate allows for the integration of the electronic transceiver. The antenna has one transmit and one receive array each consisting of thirty-two (32) common connected patch elements. The total physical size of the Transceiver Module is (65 x 65 x 11) mm. The MSPA itself is (65 x 65 x 2.5) mm.

Antenna Function: The Transceiver Module functions as the only means of K-Band transmission and detection on the Falcon HR. The MSPA serves a dual purpose as both K-Band sensor and K-Band radiator. The electronics of the Transceiver Module provides a K-Band source used to radiate from the MSPA and to down convert the MSPA sensed return K-Band to be used by the processing electronics of the Falcon HR. The Transceiver Module does not have beam steering capability.

SECTION 5 - GENERAL THEORY OF OPERATION

Antenna Operation: The Transceiver Module MSPA transmit array of patch elements convert electrical current from a dielectric resonator oscillator (DRO) to linear polarized (LP) electro-magnetic (EM) energy. The MSPA receive array of patch elements convert LP EM energy to electric current fed to a Low Noise Amplifier (LNA).

Antenna Specification: The Transceiver Module is specified at +5VDC, CW operation, 12k ohm load, and +25C. Maximum Radiated Power and Spurious Emission are +20dbm and -30dbm respectively. Typical 3db Antenna Beam-widths are 12 degrees Azimuth and 24 degrees Elevation. Typical Antenna Side-lobes and Sensitivity are -18dbm and -110dbm respectively. The total Transceiver Module weight is 75gm typical.

Moving Mode: In moving mode a portion of the transmitted signal reflects from the surface of passing stationary objects back to the antenna. This returning signal is the "groundspeed" Doppler. From the antenna, it travels to the Digital Signal Processor (DSP) where the signal is translated to the speed of the patrol vehicle (groundspeed) and is displayed in the PATROL window.

Kustom Signals radar has a patented feature using the patrol vehicle's speed sensor pulses, which steers the DSP processor to look for the "groundspeed" Doppler signal in a specific speed range. This feature will eliminate the often-annoying anomalies such as shadowing, combined patrol speeds, splitting speeds, and displaying speeds in the PATROL window when stopped at a traffic light or sign.

Moving Opposite Direction Mode: In moving opposite direction mode, a portion of the transmitted signal strikes an oncoming vehicle (target vehicle) and returns a Doppler frequency higher than the groundspeed because the two objects (patrol vehicle and target vehicle) are converging. This returning signal is the "target" Doppler. The processing unit measures this speed of convergence, or combined speed.

SECTION 5 - GENERAL THEORY OF OPERATION

Target Doppler Signal: Upon receiving the "target" Doppler signal, the processing unit automatically computes the difference between the speed of the patrol vehicle and the target vehicle. The speed of the approaching vehicle registers in the TARGET window. If, for example, a patrol vehicle is traveling 88 km/h and an approaching vehicle is traveling 104 km/h, the Falcon HR would process the groundspeed of 88 km/h and the combined speed of 192 km/h. The DSP would subtract the patrol speed from the combined speed ($192 - 88 = 104$). The PATROL window would display 88 and the TARGET window would display 104.

Moving Same Direction Mode: In the moving same direction mode of operation, the target Doppler is received from a target traveling in the same direction as the patrol vehicle. These "groundspeed" Doppler and the "difference" Doppler signals are received and sent to the DSP. The Difference Doppler is the speed difference between the patrol vehicle and a vehicle traveling in the same direction. The Falcon HR uses its directional determination capabilities to automatically determine if the target vehicle is traveling faster or slower than the patrol vehicle. The unit will display the patrol speed then automatically add or subtract the "difference" speed to the patrol speed for the target speed.

If the patrol vehicle's speed was 88 km/h and a target was traveling in the same direction at 112 km/h, the Falcon HR would display 88 in the PATROL window then add the "difference" Doppler signal (24) to the patrol speed ($88 + 24 = 112$) and display 112 in the TARGET window.

5.1 MICROWAVE RF EMISSIONS

Traffic radar operators may have some questions about the biological effects of exposure to the microwave energy produced by the radar devices. According to all credible evidence, the emission levels resulting from traffic radar use pose no threat whatsoever, either to the radar operator or to target vehicle occupants.

One widely recognized authority for safe limits of nonionizing radiation exposure is the American National Standards Institute, which recommends maximum exposure levels for the frequencies on which Kustom traffic radar systems operate (ANSI/IEEE C95.1-1999, "Standard for Safety Levels With Respect to Human Exposure to Radio Frequency Electromagnetic Fields, 3 kHz to 300 GHz"). These exposure levels, expressed in terms of power density, are 10 mW/cm² for K-band and Ka-band radar units. Similarly, the Occupational Safety and Health Administration (OSHA), a division of the U.S. Department of Labor, recommends a 10 mW/cm² exposure limit for both frequency bands ("Radiation Protection Guide", 29 CFR, Chapter XVII, Subpart G, Part 1910.97). This limit is clearly accepted by most reputable scientific and medical authorities.

Kustom radar systems utilize microwave transmitters that produce aperture power densities, measured directly at the face of the antenna, in the range of approximately 0.1 to 2.3 mW/cm². Typical levels for the vast majority of units are in the 0.4 to 1.0 mW/cm² range, which is but a small fraction of the recognized safe limits. Bear in mind that these are level measurements taken directly in the main beam of the antenna, and that the power densities produced at the sides and rear of the unit are typically at least one hundred times lower than in the main beam.

SECTION 5 - GENERAL THEORY OF OPERATION

Another reference document on this topic is a DOT publication entitled "Field Strength Measurements of Speed Measuring Radar Units" (NHTSA Technical Report #DOT-HS-805 928). This report documents a series of tests performed by the National Bureau of Standards on twenty-two commonly used models of traffic radar units, from six different manufacturers including Kustom. Aperture power density levels measured were from 0.25 to 2.82 mW/cm², while back-lobe power density values ranged from 0.001 to 0.02 mW/cm². These measurements were obtained with the radars mounted inside vehicles, as in normal operating conditions. Since the NBS study, other laboratories have duplicated these types of measurements, producing consistently similar results.

For a free copy of the latest information regarding the safe human exposure standards, please call or write Kustom to request the "RF Emissions Packet." You may contact us at our corporate headquarters:

Kustom Signals, Inc.
9652 Loiret Blvd.
Lenexa, KS 66219
(913) 492-1400

While traffic radar devices do emit microwave energy, the levels are so low that there are no probable harmful effects. You may use your Kustom radar unit with complete confidence in its safety, as well as in its accuracy.

6. TESTING PROCEDURES

6.0 GENERAL

The internal circuit and antenna tests are periodically performed automatically while the unit is in use.

6.1 POWER ON

Press and release the PWR switch. The unit will turn on all the LCD segments for a display test and perform a crystal cross check to verify the accuracy of the speed processing circuitry.

If these tests pass, the unit will display “PAS” in the TARGET display window, stationary mode, or in both TARGET and PATROL display windows in the moving mode. This will remain for approximately one (1) second. The displays will clear and the unit will be operational.

6.2 AUTOMATIC SELF-TEST

As long as the unit is turned on, the Falcon HR performs an internal accuracy test every 5 minutes or whenever the unit's mode of operation is changed, such as moving to stationary, and each time the target speed is locked.

This test is automatic and will not interfere with any radar speed readings being taken. The test passing does not appear in the displays, but if an error is detected during this test, the TARGET window will indicate “Err” and further speed-readings are prohibited.

6.3 MANUAL TEST

The operator can manually perform the indicator and internal tests at any time during normal radar operation—just press and release the Test switch. The indicator test will be performed followed by the display of “PAS” in the TARGET window in Stationary Mode and in both Target and PATROL windows in Moving Mode.

NOTE: The unit will remain in the TEST state for 30 seconds after releasing the TEST switch, indicated by the flashing TEST indicator.

6.4 SPEEDOMETER VERIFICATION

Before the Falcon HR can be used with the speedometer pulse input, the radar unit must be synchronized with the speedometer.

1. After installation, the Falcon HR should be driven at a constant speed, between 48 and 112 km/h. Press the PAT SEL switch on the remote control twice. “Snc” will appear in the TARGET window and patrol speed will appear in the PATROL window.
2. Verify the patrol speed displayed matches the speedometer reading, and press the LOCK/REL switch. This tells the DSP processor that the current speedometer reading and the Doppler patrol reading agree, within speedometer tolerance limits.
3. Within two (2) seconds, a synchronization number will appear in the LOCK window. Typically this number will be around 50 for Ford products. This indicates the Falcon HR is reading and comparing the speedometer speed input and the true Doppler patrol speed.

NOTE: Only the actual Doppler signal is used for the Patrol Speed. The speedometer input is used only to steer or guide the DSP to search for the Patrol Doppler signal in a specific area, ignoring signals in other areas.

4. During normal operation, at patrol speeds below the minimum limit of 16 km/h or when a “groundspeed” Doppler signal cannot be found, the PATROL window will display two dashes (--), indicating that the speedometer speed is being received but a patrol speed cannot be found or displayed. As an example, when a patrol vehicle is slowing down and the speed drops below the minimum speed, dashes will be displayed.

6.5 MINIMUM PATROL SPEED SET

1. When the speedometer input feature is not used, the Falcon HR allows the operator to set a minimum patrol speed of 16, 32, 48 or 64 km/h.
2. To activate this feature, place the unit in the moving mode and press the PAT SEL switch one (1) time. The unit will display “P” in the Patrol window and the last selected minimum patrol speed will be displayed. Default is the lowest value 16 km/h.

To change the value, immediately press the remote’s LOCK/REL switch. Repeat until the desired value appears. Once the desired minimum value is selected, the unit will time out in 2 seconds and the last displayed value will be accepted as the new minimum patrol speed.

6.6 MOVING MODE TEST

Verification of speed readings between the patrol vehicle's speedometer and the Falcon HR's PATROL speed display is another accuracy test that can be performed. These readings should be the same, or within reasonable limits, allowing for minor speedometer error.

Speedometer checks should be done on a daily basis. If a discrepancy is found, the radar unit should be removed from service until the error can be corrected.

7. OPERATION

7.0 OPERATING MODES

The Falcon HR radar system offers the operator one of the most versatile traffic radar systems available today. It can be used in handheld or dash-mounted in 5 different operating modes.

1. Stationary ALL
2. Stationary Approaching Only
3. Stationary Receding Only
4. Moving Opposite Direction
5. Moving Same Direction

NOTE: The following guide to operating the Falcon HR radar system is not intended to be a training program. Before operating this unit or any other traffic radar system, Kustom Signals recommends that all operators have prior training in radar speed monitoring devices. Such courses are offered by Kustom Signals, various state and local agencies and either IPTM (Institute of Police Technology and Management) or Northwestern University.

7.1 OPERATIONAL SETUP

For handheld operation, use the corded or battery handle. The corded handle requires external power from a portable battery pack, auxiliary power receptacle, or the patrol vehicle's cigarette lighter receptacle. For complete portability, use the optional battery handle.

For dash mounted moving or stationary operation, the Falcon HR can use the corded or battery handle, or the optional mounting pod. Dash mounted units with a

SECTION 7 - OPERATION

handle, use the wireless IR remote. Units with the optional mounting pod can use either the wireless or the wired remote. The speedometer cable (if used) can be connected to the optional mounting pod.

7.1.1 BATTERY CHARGING

For cordless operation, the Falcon HR battery handle must be charged before use. The battery may be charged while attached or removed from the unit. To remove the battery handle, turn the unit upside down, press the blue handle release button (latch) located directly behind the handle, and slide the handle off the unit. Connect the battery charging cable to the input connector on the bottom of the handle.

The standard charger supplied with units sold in the United States is a trickle (timed) charger, which will recharge the Falcon HR's battery in 14-16 hours then shut itself off. The charging time will vary depending upon the amount of discharge, but typically overnight will completely charge the Falcon HR's battery. Please note—any interruption in the 110V power supplied to the charger will cause it to reset and begin the charging cycle again.

The optional fast charger allows charging directly from the vehicle's cigarette lighter receptacle. When using this charger, the Falcon HR may be operated with no decrease in the radar's effectiveness. Charging will take less than 2 hours, even with the radar in normal use. The optional AC adapter allows charging from standard AC current (110V or 220V). Charging will take approximately 1 hour, and is shown by a steady green LED. Full charge is shown by a flashing green LED. Once full charge has been reached, the charger ceases charging and goes into a maintenance mode, protecting the battery against overcharging. A red LED indicates the battery is out of temperature tolerance and cannot be charged until its temperature falls within the proper range.

7.1.2 BATTERY OPERATION

The Falcon HR has an onboard battery monitor that notifies the operator when battery voltage (internal or external) is approaching or has fallen below the Falcon HR regulation threshold. First the monitor senses the condition where 30 minutes of transmitting battery life remains. A flashing “BATT” indicator and an audio warning tone every two minutes notify the operator that battery life is limited. Speed data can still be taken until the internal battery voltage level drops below the minimum operating level. When minimum operating voltage is sensed, the transmitter is disabled, last locked speed is preserved and the “BATT” indicator becomes steady. When the voltage falls further, the Falcon HR shuts off to prevent complete discharge of the battery.

7.1.3 LOCATION

1. For stationary operation, select an area that provides a good view of the traffic to be monitored.
2. Check the immediate area for potential interference sources, such as large reflecting signs in the direct path of the radar’s microwave beam, power substations and other potential sources of electrical interference.
3. Position the patrol vehicle in a safe location, with easy access to the roadway.

NOTE: Cosine effect, the angle between the target’s direction of travel and the path to the radar, in the stationary mode, will ALWAYS be in the driver’s favor. Refer to the National Highway Traffic Safety Administration’s “Basic Training Program in RADAR Speed Measurement” for speed reduction information due to cosine angle.

7.1.4 ADJUSTING AUDIO

Adjust the Doppler audio for the desired listening level. Press the AUD switch. The TARGET window will display “Aud” and the PATROL window will display the current audio level. This display will remain for approximately two (2) seconds unless another switch is pressed.

While “Aud” is displayed, press either the down arrow (Audio) or up arrow (Range) to decrease or increase the audio level. The displays will return to their normal mode two (2) seconds after the last switch is released.

7.1.5 AUDIO UNSQUELCH

To unsquelch the audio, press AUD then press MODE while “Aud” is showing in the TARGET window. “Un” will be displayed, and the audio will be unsquelched. To return to squelched audio, repeat this step.

7.1.6 RANGE

Set the range control to the desired level. Press the RNG switch and “rnG” will be displayed, along with the current level (1-5). The range can be increased or decreased by pressing the up arrow (Range) or down arrow (Audio). The Falcon HR will return to normal operation with the new range level approximately two (2) seconds after the last switch activation.

Range level 5 is the maximum range, and range level 1 reduces the target detection range to its minimum distance, typically 90 meters.

7.1.7 BACKLIGHT

For low light operation, the Falcon HR has a low power consumption fiber-optic backlight. To turn the backlight on, press the TEST switch, then while all the LCD segments are on, press the MODE switch. Repeat to turn off the backlight.

7.2 OPERATION - HANDHELD

7.2.1 SETUP

1. Attach the corded or battery handle. Turn the unit on. Place the system in Stationary Mode “ALL” with the transmitter in HOLD.
2. Set the range and audio levels as needed.
3. Point the Falcon HR at the intended target vehicle, pull and hold the trigger to take the transmitter out of HOLD, and complete the tracking history.
4. Complete a tracking history on the target vehicle.
 - A. Observe the target and surrounding traffic.
 - B. Estimate the speed of the target vehicle.
 - C. Listen to the audio pitch and compare the pitch to the estimate of speed in B.
 - D. Observe the speed reading shown on the TARGET window. It should correspond with B and C above. Continue tracking the target vehicle as required for proper target identification.
 - E. If any of the above elements do not agree, the reading must be disregarded.

7.2.2 TARGET LOCK

1. To lock the target speed reading, release the trigger. A short audio alert tone will be heard in the speaker and the target speed will be locked and flash in the LOCK window.
2. To allow additional tracking of the target vehicle, the Falcon HR will continue to transmit and display the Target speed for 5 seconds after the trigger is released. At the end of that time, the TARGET display will blank.
3. To release a locked speed, pull and release the trigger. The LOCK window will blank. No speeds can be recalled.

NOTE: Some models, due to state or local law, require an automatic unlock feature. The Falcon HR software has a feature that, when enabled, will unlock all locked speeds when 15 minutes has elapsed.

7.2.3 FASTEST VEHICLE MODE - (OPTIONAL FEATURE)

Falcon HRs that have the optional fastest feature will power up with fastest turned on. To toggle this feature on and off, quickly double click the trigger. Fastest is on when the FAST indicator is displayed.

The fastest target will be displayed in the FAST/LOCK window. The arrow graphic indicators adjacent to the window show the direction of travel (approaching or receding) of the fastest target. Both fastest direction indicators will remain on solid until a fastest target is found. When a fastest target is found, only the indicator representing the targets direction of travel will be visible and flashing.

7.3 OPERATION - DASH MOUNTED

7.3.1 SETUP

For dash-mounted moving / stationary operation, the Falcon HR can use the corded or cordless handle or the optional mounting pod.

Units with the optional mounting pod can use either the wireless or the wired remote. The following steps describe connecting the mounting pod.

1. Turn unit off; unplug power cord. Remove the handle from the Falcon HR by pressing the handle release button (latch) on the bottom of the indicator.
2. Slide the indicator onto the mounting pod, pushing rearward until the release button clicks, indicating the unit is securely in place.
3. Connect the remote control and speedometer input cables as required. Plug the unit in, turn on.

Dash mounted units with a handle use the wireless IR remote and must use the KSI provided handle dash mount. This specialized mount allows the unit to detect if it is handheld or dash-mounted. While dash-mounted, the trigger is inoperable, the IR remote is active, and moving modes are allowed. While handheld, moving modes are not allowed, the remote is inoperable and the trigger must be pulled to activate the transmitter.

1. Set the range and audio levels as needed; select operating mode.
2. Aim antenna directly at vehicles being monitored.

7.3.2 STATIONARY MODE

There are three modes of stationary operation:

- Approaching only (Apr), receding vehicles not displayed.
 - Receding only (rEc), approaching vehicles not displayed.
 - All (ALL), targets from both directions are displayed and the direction of travel is indicated.
1. Complete a tracking history as described in Sec. 7.2.1 Step 4.
 2. To lock a speed, press LOCK/REL on the remote control. To release a locked-in speed, press again. See Sec. 7.2.2 for details.
 3. To shut off the transmitter, press HOLD on the remote. The HOLD indicator will light, and the TARGET display will blank (locked speeds will remain). To return to normal radar operation, press HOLD again.
 4. The Falcon HR allows two methods of fastest vehicle mode operation while dash-mounted (push and hold or toggle control). See the Sec. 14.1.5 for selecting the preferred method. When the fastest mode is activated, the FAST indicator will light, the fastest speed will be displayed in the LOCK window, and the strongest signal speed will be displayed in the TARGET window.

7.4 MOVING MODE - OPPOSITE DIRECTION

1. Place the Falcon HR in the moving mode by pressing the Mode switch, if needed, so that both the TARGET and PATROL windows' indicators are lit. If necessary, select Opposite Direction mode by pressing SAME/OPP switch on the remote control (the opposite road graphic indicator will be lit).
2. If the speedometer input feature is not used, check the setting of the minimum patrol speed. To display the existing patrol minimum setting, press the PAT SEL switch one (1) time. To change the patrol minimum settings refer to Sec. 6.5 (MINIMUM PATROL SPEED SET).
3. While driving, observe traffic and complete a tracking history as described in Section 7.2.1 Step 4 and verify the radar's patrol speed reading with the patrol vehicle's speedometer. When all elements agree, enforcement action may be taken.

NOTE: If an incorrect Patrol speed is obtained, the operator can go in and out of HOLD quickly. This will clear all previous speeds, and a new patrol speed search will be initiated. See Sec. 7.7

7.4.1 HOLD MODE

The Falcon HR may be placed in the Hold mode (non-transmit) by pressing HOLD on the remote control. The HOLD indicator on the rear panel of the Falcon HR will light and the displays will blank (locked speeds will remain). To return to normal radar operation, press HOLD again.

7.4.2 MOVING MODE – TARGET LOCK

1. To lock the target speed reading, press the LOCK switch on the remote. A short alert tone will be heard, and the LOCK window will display the speed of the target vehicle.
2. The Falcon HR will continue to track the target and patrol speeds.
3. When the patrol vehicle's speed has dropped 16 km/h below the speed when lock was activated, or the Falcon HR is placed in Hold, the patrol vehicle's speed, at the time of lock, will flash in the PATROL window.

NOTE: This allows the operator to continue to track the target while monitoring the patrol vehicle's speed and still retain the locked patrol speed.

4. The locked speeds may be unlocked by:
 - A. Pressing the remote's LOCK/REL switch.
 - B. Auto-unlock after 15 minutes, if activated.
 - C. Changing the mode of operation, moving to stationary.

7.4.3 MOVING MODE – PATROL BLANK

The operator may blank the locked patrol speed display by pressing the "PAT SEL" switch. Pressing the switch again will return the locked PATROL display.

7.4.4 MOVING MODE – FASTEST VEHICLE (OPTIONAL FEATURE)

1. With the unit operating in the moving mode, observe traffic.
2. The Falcon HR allows two methods of fastest vehicle mode (Push and Hold or Toggle control). See Sec. 14, Options, for selecting the preferred method. When the fastest mode is activated, the FAST indicator will be turned on.
3. When a fastest target is detected, the FAST indicator will flash and the fastest speed will be displayed in the LOCK window. The fastest arrows, indicating approaching fastest or receding fastest, will indicate the direction of travel of the fastest target. The TARGET window will continue to display the strongest signal speed and the patrol speed will continue to track.

7.4.5 MOVING MODE – FASTEST VEHICLE LOCK

1. To lock the fastest vehicle speed, momentarily press the LOCK/REL switch on the remote control.
2. If the fastest vehicle speed is locked, the Target window will display the current fastest target (for track-through-lock history) and the FAST indicator will continue to flash, indicating the locked speed was obtained as a fastest target. If the strongest vehicle speed is locked, the TARGET window will continue to show the strongest target, and the FAST indicator will be turned off, indicating the locked speed was obtained as a strongest target.

7.5 MOVING MODE – SAME DIRECTION (OPTIONAL FEATURE)

1. Select the moving mode, same direction by pressing the SAME/OPP switch on the remote control. The same direction road graphic indicator will be lit.
2. While driving, observe traffic traveling the same direction as the patrol vehicle.
3. Complete a tracking history, and verify the patrol speed agrees with the speedometer speed reading.

NOTE: Vehicles traveling at the same rate of speed as the patrol vehicle will not qualify as targets. The minimum difference in speed between the patrol vehicle and the target vehicle is 5 km/h. The maximum difference is $0.65 \times \text{Patrol Speed}$ (65% of Patrol Speed). (For a patrol speed of 80 km/h, the maximum difference speed would be 52 km/h.)

NOTE: If an incorrect Patrol speed is obtained, the operator can go in and out of HOLD quickly. This will clear all previous speeds, and a new patrol speed search will be initiated. See Sec. 7.7

4. The Falcon HR can automatically detect whether the target vehicle is traveling slower or faster than the patrol vehicle. There is no need for the operator to input slower or faster information for same-direction targets.
5. The Fastest feature can also be used in the Same Direction mode. To qualify as a fastest speed, the target must be faster than both the strongest target and the patrol speed.

7.6 SPEEDOMETER PULSE OPERATION

The Falcon HR has hardware and software in place to interface the unit to the patrol vehicles speed sensor. The speed sensors input pulses steer the DSP in the search for the Doppler patrol signal. This patented technique virtually eliminates problems of patrol shadowing and patrol combining.

Once the synchronization procedure has been completed, no further action is needed unless the Falcon HR has been placed in another patrol vehicle. If so, the operator must repeat the synchronization procedure for the new vehicle if he wishes to use the speedometer pulse input.

The radar may be operated with or without the speedometer pulse input. If it is not connected to the speedometer pulse input, it will operate as standard directional radar. If the Falcon HR is connected to the speedometer pulse input, it will operate as a standard directional radar on power up. When speedometer pulses are detected, it will automatically begin using the stored synchronization code.

7.6.1 Automatic Mode switching

The Falcon HR with speedometer interface that has been synchronized will perform **Automatic Mode Switching (AMS)**. When the unit has received speedometer pulses, after power up, it will automatically switch to moving mode while the vehicle is traveling and to stationary mode when the vehicle stops.

<p>NOTE: AMS will not change modes if the operator has Locked speeds. If speeds were Locked in stationary mode and then the vehicle begins traveling, the unit will be placed in Hold.</p>

7.7 SMART PATROL SEARCH

The Falcon HR can be operated with or without speedometer input. If the speedometer input is not connected, the unit will use patented Smart Patrol Search (SPS) software routines. This software reduces patrol shadowing and patrol combining when coming out of Hold mode by knowledge of how traffic radar is typically used by the operator.

When using traffic radar in moving mode, typically the operator will activate and deactivate the antenna transmitter as needed to check the speed of target vehicles. The radar may have been in Hold anywhere from several seconds to several minutes. Each time the operator switches from Hold to active mode, the unit must first capture the patrol vehicle speed before any target speeds are processed. It is during this initial capturing from Hold that radar processing is the most vulnerable to patrol shadowing or combining.

SPS software works by storing the patrol speed when the operator enters the Hold mode. This has two purposes; 1)to help track the correct patrol signals and/or 2)reject incorrect patrol signals, when returning to active mode. If the unit is in the Hold mode for a typical amount of time (more than one second), the patrol will be searched first in a region around the stored patrol speed.

Example: The patrol vehicle is traveling 100 km/h and the operator enters Hold mode. When the operator comes out of Hold sometime later, the SPS software will search the region around 100 km/h first for the patrol signal. If a 30 km/h shadowing signal was present, it is not likely to be displayed as a false patrol.

If, on the other hand, the unit is in Hold for a short amount of time (less than one second), the region around the saved patrol will be excluded from the initial patrol search. While the last patrol speed is being rejected from the search 're-' will be displayed in the Patrol window.

Example: The patrol vehicle is traveling 40 km/h, there is a strong approaching target traveling 72 km/h, and the radar has mistakenly combined the two and is displaying 112 km/h for patrol. The operator can quickly go in and out of Hold to reject the region around 112 km/h and the correct 40 km/h patrol speed will be displayed.

7.8 MAINTENANCE MODE

The Falcon HR has a maintenance/configuration mode which can be used for diagnosis and configuration. Holding the PWR switch depressed for 3 seconds or longer during power up accesses this mode. Turning the unit off and back on again will exit this mode.

7.9 TEST SCREEN MODE

The test screen mode is not for normal operations but is to augment troubleshooting and test lab operations.

Pressing a combination of buttons can enter the test screen mode. First press and release the TEST button. During the test sequence, while all display segments are on, press the RNG button. The unit will enter test screen mode, and the TEST indicator will be on solid.

To exit test screen mode, press the MODE or TEST switch or cycle power on the unit.

8. INFLUENCES AND INTERFERENCE

Interferences from external sources may affect the standard operation of any radar device, including the Falcon HR. These influences can be natural or man-made, however, the Digital Signal Processing circuitry will eliminate most of these influences and a knowledgeable operator should be able to determine the nature of the influences and their effect, if any, on the performance of the Falcon HR.

8.0 NATURAL INFLUENCES

1. Heavy rains and blowing dust can cause a scattering effect, which may reduce the effective range of the Falcon HR. The patrol speed can also be affected by driving rain. It is recommended that the operator compare the patrol speed reading and the speedometer reading frequently during rainy periods.
2. Terrain can affect the range of the Falcon HR. Improper aiming of the antenna can cause the radar to appear to have short range. If the target vehicle were on a slight incline, the antenna could be shooting short of the intended target vehicle.
3. Strong reflections from roadside objects, such as large signs, parked cars and buildings can cause double bounce reflections, which appear to be targets traveling at the same speed as the patrol vehicle. The DSP will analyze signals that are the same as the patrol speed, if it is determined they are possible “harmonics” from double bounce the TARGET window will display “- -“ until this condition no longer exists.

8.1 MAN-MADE INFLUENCES

1. Radar units may display incorrect speed readings from various sources. These include shadowing, combined speeds, moving cosine and fan interferences (splitting speeds).
2. Patrol speed shadowing may occur when the radar unit receives a stronger signal from a large vehicle traveling the same direction than the groundspeed return signal of the patrol vehicle. This difference speed may be placed in the PATROL window and used instead of the proper patrol speed. See Sec. 8.2.
3. The combined speed effect can occur when the patrol vehicle and the target vehicle are approaching each other at low speeds, usually in the 40 to 56 km/h range each, and at relative short distances, usually less than 100 meters. The radar unit sees a strong reflection from the combined speed signal and may display this speed instead of the true patrol speed. The Falcon HR with speedometer input will eliminate this effect, and the unit will display the proper patrol and target speeds.
4. The Falcon HR has an onboard battery monitor to alert the operator when internal voltage nears the minimum operating voltage. See Sec. 7.1.1 for details.
5. Radio Frequency Interference (RFI) exists when there are strong RF transmitters in the immediate area of the radar unit, such as the patrol vehicle's transmitting radio, high power radio or television stations. Normally these signals are processed as non-moving and not

SECTION 8 - INFLUENCES AND INTERFERENCE

displayed as targets. However, if the RFI signals are strong enough, the Falcon HR will detect these sources of interference, the TARGET window will display “rFi” and all speed-readings will be blanked, except for locked speeds, until the source of interference is reduced or eliminated.

6. Heater and A/C fan motors can cause a radar unit to display the fan’s speed, rather than a weaker target vehicle’s speed. A trained operator should not be confused by intermittent fan readings and the distorted audio. Proper antenna mounting, placement, and aiming will eliminate most of the potential fan interferences.

NOTE: If there are still problems with fan interference in your type of patrol vehicle, Kustom Signals can provide antenna noise reduction pads to prevent the fan signal from reaching the antennas. Contact your District Sales Manager or Kustom Signals' Customer Service department for antenna pad options.

7. Vehicle ignition interference, See Sec. 3.2 for further details.

NOTE: Refer to the National Highway Traffic Safety Administration’s Basic Training Program in RADAR Speed Measurement for further information on interferences and training guides.

8.2 GROUNDSPEED

True groundspeed of the patrol vehicle is required by all moving traffic radar systems before a target vehicle's speed can be accurately computed. If the Falcon HR loses correct groundspeed, the operator can recapture groundspeed by quickly activating and then deactivating the HOLD mode.

If the speedometer input is being used with the Falcon HR, the DSP will accurately track even a weak patrol speed return due to the small tracking window, unlike radar without speedometer input.

The Falcon HR will always look for and display groundspeed before displaying any targets. The groundspeed radar signature is unlike most target or interference signals. The DSP can identify this pattern, which is helpful in situations such as shadowing or combined speeds. While the speedometer input and DSP technology will eliminate most of the influences found in moving radar, it is still the responsibility of the operator to complete a tracking history on the target vehicle and verify the patrol speed with the patrol vehicle's speedometer. Close observation of the patrol vehicle's speed reading is recommended to avoid possible confusion.

<p>NOTE: The Falcon HR will not display patrol speeds below 16 km/h, or below the patrol minimum setting if the speedometer input is not used.</p>

Operating moving radar in the rain and snow requires the operator to pay close attention to the patrol speed. Since rain, fog and snow may affect the ability of the radar system to find groundspeed, the operator must verify the displayed patrol speed reading is correct.

9. CARE OF THE FALCON HR

The Falcon HR radar system is designed for long reliable use by law enforcement agencies. Following basic care guidelines will ensure the unit gives many years of trouble-free service.

9.0 ROUTINE CARE

1. Use a damp cloth to clean the outside of the radar unit if it becomes dirty. **DO NOT** use excessive water or any cleaners or sprays on the outer surface of the Falcon HR's mounting pod or remote control.

2. **WARNING! AVOID HIGH PRESSURE SPRAY!**

As with all electrical or electronic equipment, protect the unit from water. While the Falcon HR is weather resistant, the radar unit, the mounting pod and remote control are not waterproof. If any liquid should get inside, remove power immediately and send the unit in to a repair facility. Prompt action can minimize any damage.

3. If the Falcon HR is used outside in rain or snow, it should be wiped dry with a clean cloth as soon as practical.
4. There are no user serviceable parts in the Falcon HR. The internal battery handle is over-current protected by an automatically resetting fuse. The fuse for the corded handle and mounting pod is located in the end of the cigarette lighter plug. Simply unscrew the tip and replace with the same size fuse.
5. Do not pick up or carry the Falcon HR by the power or remote control cables. Broken power and remote control cables are a common cause of intermittent operation.

6. Kustom Signals recommends periodic maintenance of the Falcon HR radar system. Check with your local service center and judicial district for requirements.

9.1 EQUIPMENT REPAIR/RETURN

Should the Falcon HR need repair or calibration from Kustom Signals Customer Service, please visit our website (www.kustomsignals.com), click on Service Support→ Return & Repairs and follow the instructions on the Returns Form to receive a Return Material Authorization (RMA) number. If you do not have access to our website, please call our Customer Service Department at (800) 835-0156 or (620) 431-2700 to obtain your RMA number before returning your unit. The following information will be needed:

1. Serial number of unit, department name, return shipping address, contact name at owning department, and phone number.
2. Complete description of failure or problem with unit. Please describe, in detail, what the failure is and when it is observed. EXAMPLE: In moving mode, targets are close to patrol vehicle before being displayed. Target speeds are not multiples of patrol speed.
3. Method of return shipment.

NOTE: Kustom Signals will return the unit via Ground transportation unless otherwise directed.

9.2 BATTERY DISPOSAL

It is a violation of Federal regulations to dispose of rechargeable batteries in a landfill. They must be recycled at an appropriate facility, disposed of in accordance with local ordinances, or shipped back to Kustom Signals for disposal. For more information on disposal facilities near you, contact the Rechargeable Battery Recycling Corp. (RBRC) at 1-800-8-BATTERY, email rbrc@rbrc.com, web page www.rbrc.com.

10. CANADIAN CASE LAW

This section is included so radar operators and those individuals responsible for prosecuting traffic arrests can familiarize themselves with the more important legal cases involving the use of traffic radar. To obtain additional information on the referenced material, consult your community's local law library or the prosecutor's office.

Since the Falcon HR is a Doppler based traffic radar system, some older case law is presented because of its significance to the acceptance of the Doppler principles as well as the basic requirements of operator training.

R. v. Grainger (O.C.A.) 1958

Speed by radar: Counsel argued it must be established that radar, when properly used, was capable of registering speed of a motor vehicle on a highway and that the machine was in good working condition and was properly used.

HELD: On summarized evidence it was implicit that radar when properly used is capable of registering speed of motor vehicle and at time was being properly used and in good working order. As defence merely claimed but did not show machine subject to weaknesses, conviction proper on weight of evidence.

R. v. Werenka (Alta. Q.B.) 1981

ISSUE: What evidence Crown must establish to prove prima facie case where speed by radar.

HELD: Crown only had to prove prima facie case. Not obliged to demonstrate that the instrument was capable of accurately registering speeds over the entire range of the instrument where there was no evidence to throw doubt on the officer's evidence.

1. qualified operator

SECTION 10 - CASE LAW

2. tested and accurately measured the speed of the appellant's vehicle
3. evidence prima facie notwithstanding that the officer did not have a detailed knowledge of the working of the radar set.

R. v. Joudrey (1992) Nova Scotia Prov. Court

The accused was charged with speeding contrary to s. 106(2) of the Motor Vehicle Act. The night of the alleged offence was foggy and drizzly. The accused insisted that he was not driving over the speed limit and challenged the accuracy of the RADAR readings. His lawyer cross-examined the RADAR operator and, in doing so, referred to a textbook, "the Law of Speeding and RADAR", and specifically to passages stating that certain atmospheric or environmental conditions could give spurious readings. The court did take judicial notice of the passages in the textbook and the accused was acquitted.

Griffin v. the Queen (N.S. Cnty. Crt.) 1980

Officer testified the appellant traveled at 107 kilometres in a zone marked for a maximum of 80 kilometres. He neither described the speed in terms of "kilometres per hour", nor did he describe the purpose or functioning of the radar gun. HELD: Judicial notice could be taken of the functioning of the radar gun. While the description of the speed was imprecise, the intended meaning was clear.

R. v. Longmire (1993) Nova Scotia Supreme Court
(Appeal Div.)

The appellant's conviction was affirmed on appeal. The appellant appealed further, arguing that the trial Judge erred in his interpretation and application of s. 88(5) of the Motor Vehicle Act and that the Crown's refusal to provide him with a copy of the RADAR operation manual violated his rights under ss. 7 and 11(d) of the Charter, preventing him from making full answer to the charge. Defence counsel indicated that his reason for asking for the manual was "so that the defence can make itself familiar with the particular operation of this RADAR unit and in order that we can intelligently cross-examine the Crown with regards to how he operated the RADAR on that day." He also wished to have the manual to review sources of interference that may make the unit susceptible to inaccuracies. In addition, the testing procedure was sought for review. The Crown, in response to the preliminary motion, indicated that it would not provide a copy of the manual, but would consent to an adjournment so the defence could hire an expert in the operation of the RADAR machine. The trial Judge declined to order a stay, as defence requested, but did grant an adjournment so that defence counsel might obtain the manual from another source. Defence counsel did not pursue the matter of disclosure on the adjourned date, nor did they cross-examine the officer with respect to the operation of the RADAR. The appellant did not lay a rational basis or factual foundation for his claim for disclosure. In an absence of an air of reality to the request for production, there was no evidence of a breach of the Charter. The appeal was dismissed.

R. v. Windrem (May 27, 1986, Brampton Prov. Off. Appt. Ct.)

Defence agents/counsel use this case to support their argument that there must be evidence before the Court that the tests conducted on the radar device were in accordance with the accepted manufacturer's technique. It is apparent from the Judgment that the appeal was allowed as the Justice of the Peace at trial misdirected himself on the evidence. The J.P. in his reasons for judgement found that the officer had checked the radar before and after use by the accepted manufacturer's technique. That evidence was not before the J.P. at trial.

R. v. Furlong (P.O.A.) 1985

Defence agents/counsel use this case to support their argument that the officer must state in evidence " I tested the radar..." It is apparent from the Judgment on appeal, that the appeal was allowed due to the fact that the J.P. at trial misdirected himself on the evidence before him. The J.P. found as a fact that the officer was the person that did the testing, because there was no one else in the police car. There was no such evidence before the J.P. at trial.

R. v. Wagner (1999), Ontario Court of Justice

The appellant in this case was charged for speeding and requested a trial. The officer in charge of the matter encouraged the woman to plead guilty in exchange for a reduction of the offence by 10 km/h. The officer later had a paralegal approach the woman and offer his unsolicited opinion that she was unlikely to be successful at trial and should accept the officer's reduction, which she did and plead guilty. She later appealed the conviction citing that she had been intimidated into the agreement. In his ruling, Judge K.P. Evans stated, "This long time practice of having the charging police officer attempt to negotiate a plea or arrange a settlement of a case such as this, is archaic and fraught with dangers to the integrity of our judicial system as it stands today. The responsibility for offering or accepting any plea negotiations are solely within the jurisdiction of the Provincial Prosecutor assigned to the said Court." The appeal was granted and a dismissal was ordered.

R. v. Meyer (P.O.A. Appeal Crt.)

On appeal, Court held that there must be evidence that the radar device was "capable of registering the speed of vehicles".

R. v. O'Reilly (Alta. Dist. Ct.) 1979

Where Crown failed to adduce evidence that the radar set was capable of accurately measuring the speeds and that the tests were approved tests, which evidence would have been given by the officer who testified, then appeal must be allowed and conviction set aside.

NOTE: Speeding is an offence of absolute liability. This means that MENS REA (a guilty mind) is not an element that must be proven. Guilt follows proof of the ACTUS REUS (proscribed act).

Because speeding is an absolute liability offence, a defence argument that, owing to a defective speedometer the accused honestly believed that he or she was not exceeding the speed limit, would not be successful.

R. v. Lounsbury (1993) Manitoba Court of the Queen's Bench

The accused was charged for speeding. The RADAR operator testified at trial that it was his usual practice to test the unit both before and after issuing an offence notice, but he had no independent recollection of performing the tests in this case. He made a note in his notebook that he had performed a test or tests, but did not note the time of the test. The accused was convicted and appealed. The appeal was allowed.

Evidence as to the operator's usual practice did not constitute proof beyond a reasonable doubt that the RADAR device was operation in this case. All that could be safely inferred from the RADAR operators testimony and notes was that he tested the RADAR device and found it to be in good working order at some point or points during the relevant shift. As a result, the appeal was allowed and the conviction was quashed.

R. v. Friedlan (1993) Ontario Court of Justice (Prov. Div.)

Where a person is charged with speeding in a construction zone, the onus is on the Crown to prove that the portion of the highway travelled was designated as construction zone under s. 128(8) of the Highway Traffic Act. Pursuant to s.128(9) of that Act, such designation is not a regulation within the meaning of the Regulations Act.

In this case, despite the fact that the officer testified that this was a construction zone in question and the area was clearly posted as an 80 km/h zone, the court allowed the conviction, but amended the offence to indicate the non-construction zone speed limit of 100 km/h.

Quebec c. Robitaille (1991) Quebec Court of Appeal

A police officer who was following the accused's vehicle testified that the speedometer of his own car recorded a speed of 140 km/h while the speed limit was 90 km/h. At the end of the Crown's case, the accused moved for non-suit on the grounds that the speed at which he was travelling was not established. This argument was rejected and the accused was convicted. On appeal by trial de novo, the Superior Court quashed the conviction. The Crown appealed.

The appeal was allowed and the conviction was restored. If a speed established by a RADAR device is sufficient prima facie evidence, a fortiori is the speed recorded by the speedometer. Expert evidence establishing the speed at which the accused was driving is not required, since the accused had not adduced evidence raising a reasonable doubt as to the accuracy

SECTION 10 - CASE LAW

of the police officer's speedometer. Therefore, the conviction was justified and had to be restored.

Quebec c. Mason (1988) Quebec Superior Court

The accused was convicted of speeding. He appealed, challenging the RADAR evidence. The appeal was dismissed. Leaving aside cases in which calibration, verification of calibration, method of operation, qualifications of the operator or other factors cast a doubt on the evidence of operation and capabilities of a device, the testimony of a qualified operator can found a conviction. Once the conditions precedent are met the fallibility of the device goes to weight. It is unnecessary to show scientifically the principles of RADAR.

R v. Strong (1988) Nova Scotia County Court

The accused was acquitted of a speeding charge. Although the trial Judge accepted the evidence of the police officer with respect to the actual speed of the accused's vehicle as indicated by the RADAR, he entered an acquittal on the basis that the Crown had failed to prove that the accused had passed a speed zone sign indicating the posted speed in the area in question. The Crown appealed. The appeal was allowed.

There was requirement in the relative statutory provision that speed zone signs be erected so as to be always visible to a motorist traversing a section of highway covered by the speed approved for that area. Common sense dictated that such could not have been the intention of the Legislature – otherwise such signs would have to be erected at each street intersection and at various intervals along all the province's roadways.

SECTION 10 - CASE LAW

R. v. Wolfe (B.C.C.C.) 1979

The officer had some training and experience operating radar set, but training "fell short" which cast doubt on the accuracy of the device and its results.

R. v. Brewer (May 19, 1988, Prov. Off. Ct. Nwkt, Ont.)

At trial, officer had stated in-chief that he was a qualified radar operator and that he had received some basic training from an experienced officer in the use of the radar. In cross-examination, the officer's qualifications were challenged,

HELD ON APPEAL: In this case, the officer could not be regarded as a "qualified radar operator" and therefore, a prima facie case was not made out.

NOTE: Can be distinguished on the facts of this case, as officer had no formal training.

R. v. Waschuk (Sask. Q.B.) 1970

Judicial notice of radar: Judicial notice may only be taken of facts which are known to intelligent persons generally, therefore, judicial notice may not be taken of meaningfulness of tests.

Radar operator should be able to give evidence as to whether the machine is in good working order and capable of recording the speed of the vehicle being tested.

SECTION 10 - CASE LAW

R. v. Axler (Unreported August 20, 1981, Prov. Off. App. Ct.)

His Honour, Provincial Court Judge R.B. Dnieper.

Radar alone is good evidence. After 42 years of use, the courts will accept as prima facie evidence, the accuracy of radar devices. No longer is radar merely corroborative evidence. It is now primary evidence.

Before the prima facie rule applies, it has to be established in evidence that:

1. the radar machine was in proper working order, and
2. the radar operator was qualified to operate the machine in question.

At all times, the onus is on the crown to prove its case beyond a reasonable doubt.

R. v. Seymour (Unreported, June 16, 1982 Prov. Off. App. Ct., County of Huron, Ont.)

The crown must establish in evidence that the officer is a person who has been properly trained in the use of the device and further, that at the time in question the radar device was operating accurately.

11. FCC INFORMATION

FCC IDENTIFIER	IVQFAL-HR
Name of Grantee	Kustom Signals Inc.

The Falcon HR has been tested and found to comply with the limits pursuant to Part 15 of FCC Rules. These limits are designed to provide reasonable protection against harmful interference in a commercial environment. This equipment generates, uses, and can radiate radio frequency energy and, if not installed and used in accordance with the instruction manual, may cause harmful interference to radio communications. Operation of this equipment in a residential area is likely to cause harmful interference in which case the user will be required to correct the interference at his own expense.

Industry Canada Certification and Model Information:

The Falcon HR meets the applicable Industry Canada technical specifications.

Certification Number IC: 1293A-KSILPK

Model: FalconHR

Warning: Changes or modifications to this device not expressly approved by Kustom Signals Inc. could void the user's authority to operate the equipment.

FCC and Industry Canada Warning Statement:

This device complies with FCC part 15 Rules and with Industry Canada's license-exempt RSSs. Operation is subject to the following two conditions:

- 1) This device may not cause interference, and
- 2) this device must accept any interference, including interference that may cause undesired operation of the device.

Le présent appareil est conforme aux CNR d'Industrie Canada applicables aux appareils radio exempts de licence. L'exploitation est autorisée aux deux conditions suivantes :

- (1) l'appareil ne doit pas produire de brouillage, et
- (2) l'utilisateur de l'appareil doit accepter tout brouillage radioélectrique subi, même si le brouillage est susceptible d'en compromettre le fonctionnement.

12. TROUBLESHOOTING

If an operating difficulty is encountered, check the following list of possible problems and solutions before returning the unit to the factory or local Service Center.

Problem	Possible Solution
No Power Indication	Check for proper voltage at cigarette plug. Reseat cigarette plug in the socket. Check fuses if using vehicle's cigarette socket.
Unit will not complete test cycle or shows ERR	Verify the power plug is secure. If the ERR message indicator is lit, power the unit off, then back on. If the problem persists, remove unit from service and record the error code.
No target readings in stationary mode	Verify unit is not in HOLD. Verify range control is set properly. Verify unit is aimed properly and the target is within range of the radar. Unsquench audio and verify that a Doppler tone is heard when targets are present. If no Doppler tone is heard, remove unit from service.

SECTION 12 - TROUBLESHOOTING

No patrol speed

Verify unit is not in HOLD.

Verify the unit is aimed parallel to the ground and straight down the roadway.

Verify there are no obstructions directly in front of the unit.

Weather conditions (heavy rain, snow or fog) may affect the unit's ability to pick up groundspeed.

Verify speedometer input is synchronized properly.

Verify the patrol speed is above patrol minimum setting and below 192 km/h.

Place unit in stationary mode and drive patrol vehicle. Verify TARGET window displays proper groundspeed. If no speed readings, remove unit from service.

Speedometer verification shows "0"

Check speedometer input cable. Verify it is connected to unit and to proper input wire.

Synchronize unit.

If above tests fail, disconnect speedometer input cable, press TEST switch and continue using radar.

SECTION 12 - TROUBLESHOOTING

No target readings in moving mode

Verify unit is not in HOLD.

Verify the range control is set properly.

Verify proper patrol speed is displayed.

Verify proper moving mode is selected.

Target speed may be a harmonic of the patrol speed. Speed up or slow down patrol vehicle.

Remove unit from service if above tests fail.

Short range

Verify the range control is properly set for the desired distance to target vehicles.

Verify the unit is aimed properly.

Verify there are no obstructions between the unit and the target.

Weather conditions (heavy rain, snow and fog) may affect the unit's range.

Check for electrical interferences.

Strong fan interference will reduce the operating range of the unit.

Remove the unit from service if the above tests fail.

13. DIRECTIONAL OPERATIONAL SUPPLEMENT

13.0 DIRECTIONAL OPERATION

The Falcon HR uses state-of-the-art electronic processing to determine the direction of travel of target vehicles. This additional information aids the officer in better target identification. This can be done by displaying the direction of travel with the motorist speed or by selecting the direction of vehicles to be displayed.

Definition of Terms:

ALL: Stationary mode: Detects both approaching and receding vehicles. – “ALL” shown in PATROL display window. The direction indicators in the road graphic will show the direction of target travel.

APr: Stationary mode: Detects approaching vehicles only. – “APr” shown in PATROL display window.

rEc: Stationary mode: Detects receding vehicles only. – “rEc” shown in PATROL display window.

Strongest: Displays speed of strongest target vehicle reflected signal regardless of speed.

Fastest: Displays speed of fastest target vehicle, which is not the strongest reflected signal.

13.1 STATIONARY ROAD GRAPHIC

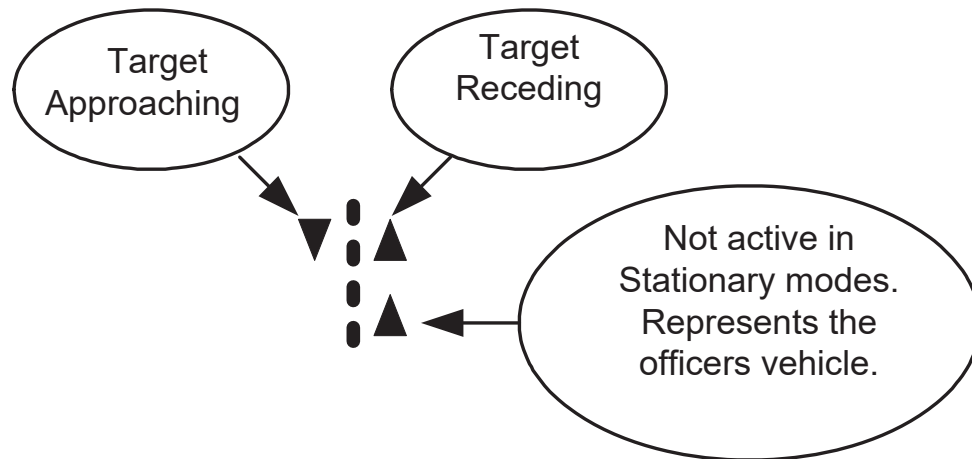

13.2 MOVING MODE ROAD GRAPHIC

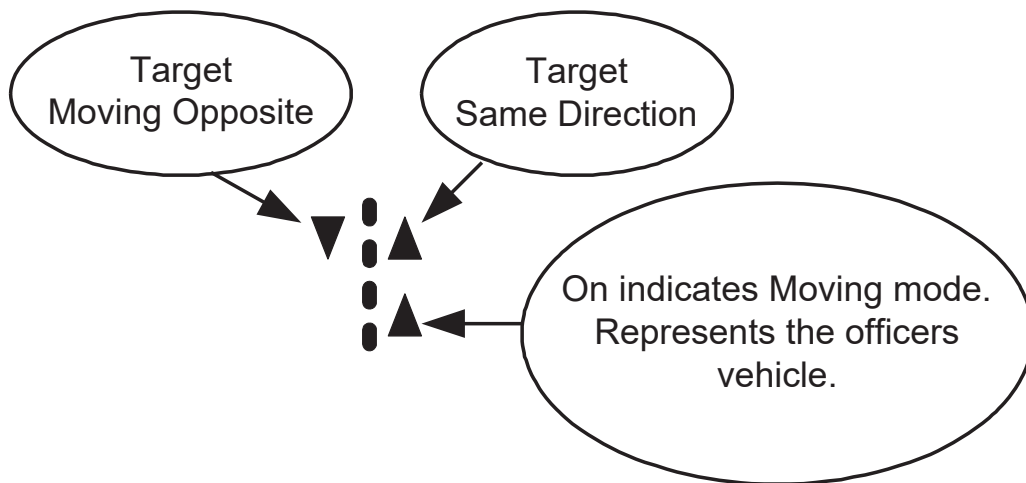

13.3 STATIONARY OPERATION

13.3.1 stationary all

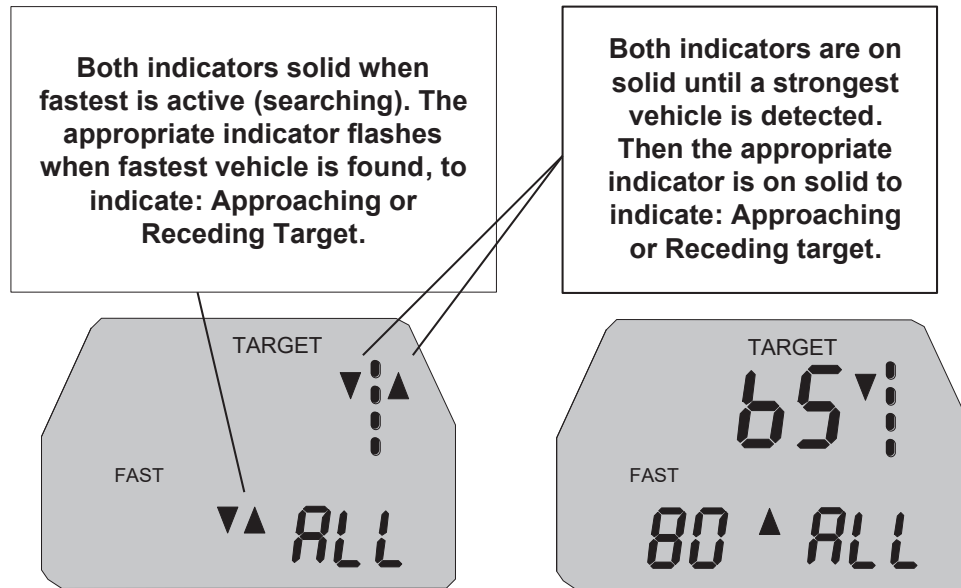

To monitor traffic in both directions (the Falcon HR will automatically indicate which direction the strongest and fastest vehicles are traveling), repeatedly depress the MODE switch until “ALL” is displayed in the PATROL window.

When the radar is operated in the Stationary “ALL” mode, the roadway graphic will light the appropriate direction LED, indicating the displayed vehicle’s direction of travel. Both approaching and receding indicators will be on solid until a vehicle is detected. After a vehicle is detected, the appropriate direction indicator (approaching or receding) will be on solid.

If the “Fastest” function is activated, both the approaching and receding “fastest” indicators will be on solid until a vehicle faster than the strongest vehicle speed is detected. The appropriate fastest indicator will flash to indicate the direction of the fastest vehicle: approaching or receding.

13.3.2 stationary approaching only

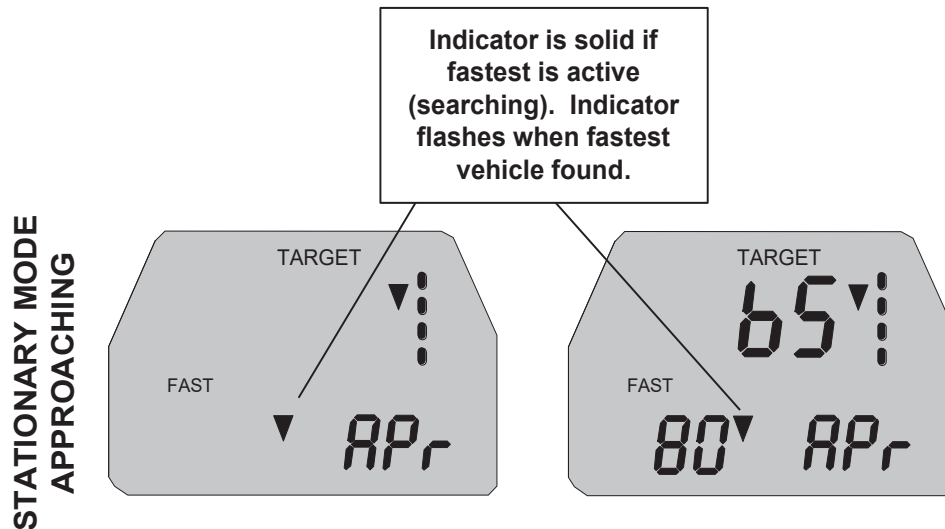

To activate the stationary, approaching targets only mode, repeatedly depress the MODE switch until “APr” appears in the PATROL window.

When the radar is operated in the Stationary Approaching mode, the TARGET window will indicate the strongest approaching target speed. The road indicator for approaching vehicles will be on solid.

If the “Fastest” function is activated, the approaching fastest indicator will be on solid until a faster approaching vehicle is detected. At that time, the approaching fastest indicator will flash and the fastest speed will be displayed in the FAST window.

13.3.3 stationary receding only

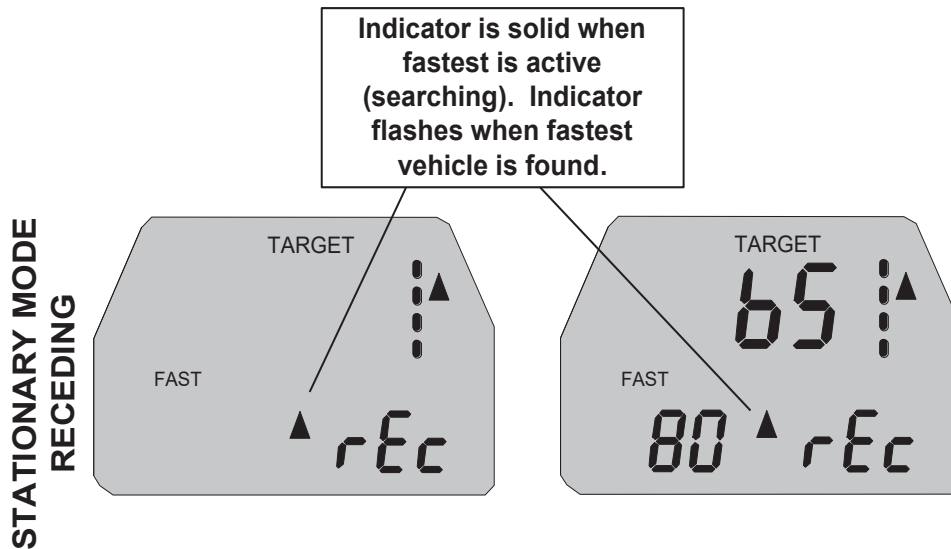

To place the unit in the stationary mode, monitoring receding traffic, repeatedly depress the MODE switch until “rEc” is displayed in the PATROL window.

When the radar is operated in the Stationary Receding mode, the TARGET window will indicate the strongest receding target speed. The road indicator for receding vehicles will be on solid.

If the “Fastest” function is activated, the receding fastest indicator will be on solid until a faster receding vehicle is detected. At that time, the receding fastest indicator will flash and the fastest speed will be displayed in the FAST window.

13.4 MOVING MODE OPERATION

Patrol Speed:

In all moving mode operations the PATROL window indicates the speed of the patrol vehicle and the patrol road graphic indicator will be lit.

13.4.1 same-direction

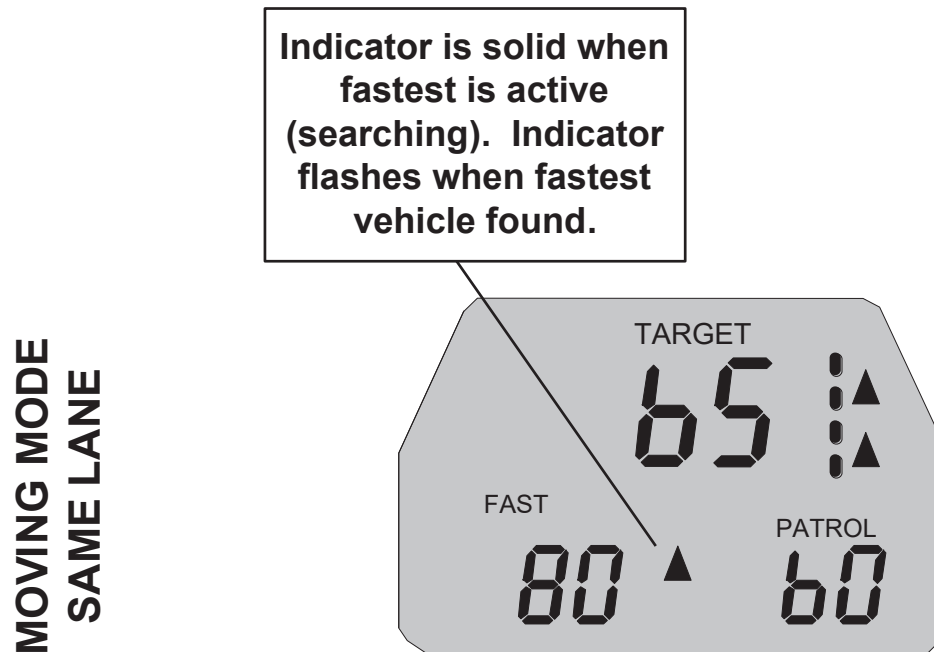

When operating the radar in Same-Direction mode, the same direction road indicator corresponding to the antenna selected will be on solid, and the strongest vehicle speed will be displayed in the TARGET window.

NOTE: The Falcon HR does not require any input from the operator in Same Direction mode. The unit will automatically detect if the target vehicle is slower than the patrol vehicle and subtract the separation speed to always provide the operator the correct speed.

Same-Direction “FASTEST”

If the Fastest feature is activated, the same direction fastest road LED indicator will be on solid until a fastest, same direction vehicle is detected, which is also faster than the PATROL vehicle’s speed. After detection, the same direction fastest indicator will flash and the fastest vehicle speed will be displayed in the FAST window.

NOTE: In the Same-Direction Fastest Mode, the “fastest” target vehicle must be faster than the patrol vehicle by 5 km/h. Example 1: Patrol vehicle = 100 km/h. Large target (strongest) = 64 km/h. Fastest vehicle = 85 km/h. In this event, no fastest speed would be displayed since the faster vehicle is ‘slower’ than the patrol vehicle.

Example 2: Patrol vehicle = 100 km/h. Large target = 64 km/h. Fastest vehicle = 110 km/h. The PATROL window will display 100, the TARGET window will display 64 and the FAST window will display 110.

13.4.2 moving opposite

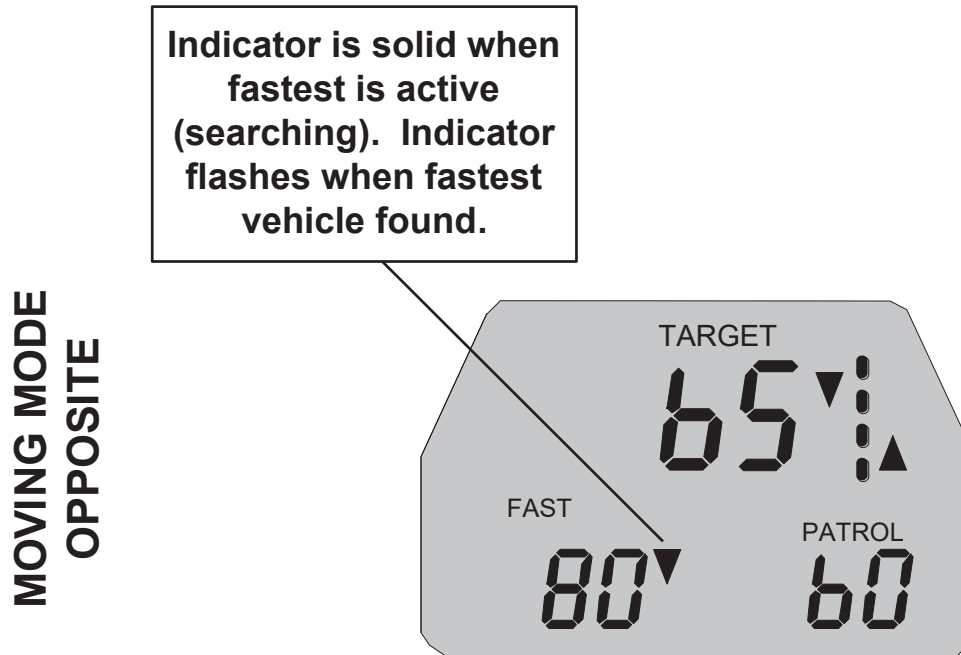

When operating the radar in Moving Opposite mode, the patrol vehicle and moving opposite road indicator will be on solid and the strongest vehicle speed will be displayed in the TARGET window.

If the Fastest feature is activated, the moving opposite fastest indicator will be on solid until a vehicle, which is faster than the strongest vehicle speed, is detected. After detection, the moving opposite fastest road indicator will flash and the fastest vehicle speed will be presented in the LOCK window.

If the operator locks a fastest vehicle, the fastest indicator will continue to flash and the TARGET window will track the fastest vehicle speed to provide a track-through-lock function.

13.5 LOCKING

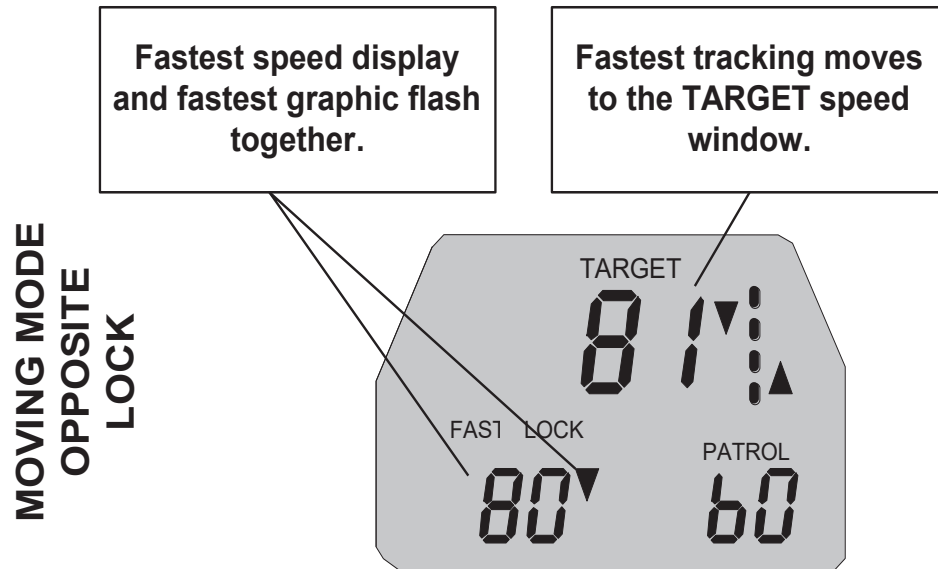

If the Lock button is pressed while tracking a fastest vehicle in any mode, the fastest speed will be locked in the LOCK window, and the fastest tracking will move to the TARGET window. After lock, both the LOCK window and the fastest indicator will flash together.

14. OPTIONS

14.0 OPTIONS SETUP

The Falcon HR radar unit allows the operator to change certain operating parameters of the unit. The following is a list of the available parameters. Each has a number after the option. An example will be given to instruct the operator how to change the unit.

<u>Option</u>	<u>Add</u>
No AUTO UNLOCK	0
Automatic UNLOCK	1
Track through Lock (5 seconds)	0
HOLD immediately after lock	2
Minimum audio level 1	4
Note: Minimum audio level 0 is not an option in Canada.	
Low power savings enabled	0
Low power savings disabled	8
Fastest - Push and Hold	0
Fastest – Toggle	16
KSI Video Output	0
Gateway Output (F)	32
Undefined Output (test)	64
Gateway Output (R)	96

km/h 128

Note: MPH is not an option in Canadian units.

14.1 OPTIONS DESCRIPTION

The following is a description of the function of each one of the Options the operator can set.

14.1.1 AUTOMATIC UNLOCKING OF LOCKED SPEEDS

The Falcon HR defaults to not automatically unlocking speeds the officer has locked. If automatic unlocking is required, add 1 to the Options total.

NOTE: Due to state regulations, if this option has been turned on at the factory, it cannot be turned off in the field.

14.1.2 track through lock (trigger operation)

The Falcon HR defaults to transmitting for 5 seconds after the trigger is released when locking a target. This allows the target to be tracked after lock during this time. If preferred, the transmitter can be shut off immediately upon trigger release. To select that option, add 2 to the Options total.

14.1.3 MINIMUM AUDIO SETTING

The standard Falcon HR defaults to allowing the audio level to be set to 0. Canadian regulations are to not allow the audio to be muted. The minimum audio level can be set to 1, add 4 to the Options total.

NOTE: Due to Canadian regulations, if this option has been turned on at the factory to Minimum Audio = 1. The audio level cannot be set to 0.

14.1.4 LOW POWER SAVINGS

The Falcon HR defaults to using very low power after 30 seconds in HOLD with no targets locked. The unit will also turn off after 30 minutes in HOLD and no operator activity. The power saving operation can be disabled by adding 8 to the Options total.

14.1.5 FASTEST OPERATION

The Falcon HR offers two modes of fastest operation from the remote control. The default mode is to push and hold the FAST switch. Fastest mode is active for as long as the operator holds down the FAST switch and for 2 seconds after it is released. The alternate mode is toggle; in this mode fastest is alternately turned on or off by pressing the FAST switch. If fastest toggle mode is desired, add 16 to the Options total.

NOTE: In handheld operation the fastest option works as described in Sec. 7.2.3.

14.1.6 INTERFACE OUTPUT PROTOCOL

The Falcon HR defaults to allow the radar unit to interface with the KSI Eyewitness[®] video or giant display equipment. Contact Kustom's Customer Service Department at (800)-835-0156 or (620) 431-2700, before changing the output protocol option.

14.1.7 SPEED READING UNITS

The Canadian Falcon HR displays the speed readings in kilometers per hour. It cannot be set to MPH readings. Add 128 to the Options value.

14.2 OPTIONS EXAMPLES

Using the above options list, add all the numbers for the options you want active. Note that default options, have a value of zero (0). To enter the Options Menu mode, power the unit off, then press and hold the POWER switch until the power-on sequence stops at the Snc display. Press the TEST switch three (3) times to advance through the maintenance screens, until OPt appears in the TARGET window and a number appears in the FAST/LOCK window. This number may be zero.

Snc screen	= speedometer synchronization value
CnF screen	= configured features value
SFt screen	= software version value
Opt screen	= users selectable options value

Using the UP and DOWN arrows (AUDIO and RANGE switches), increase or decrease the number for the value needed. To make these changes permanent (until changed again), depress the MODE switch once. When the options have been accepted, the unit will automatically return to radar mode.

EXAMPLE: The operator wishes to permanently change the operation of the unit to the following: Automatic Unlock = 1, toggle Fastest function = 16, Gateway (unencrypted) output (F) = 32 and km/h = 128. These numbers are added for a total of 177. When the menu function is entered (see above), use the UP and DOWN arrows to adjust the number shown in the FAST/LOCK window until 177 is shown. The operator would then depress the MODE switch and the changes would be accepted and used every time the radar is powered up.

A. PRINTER AND DATALOGGER

A.0 OPTIONAL FEATURE DESCRIPTION

The Falcon HR can be ordered with optional features to drive a printer and/or to log locked target speed data. The Printer feature can be setup to print a slip each time a target speed is locked or when the operator presses the MODE switch while a target is locked. The slip includes the serial number of the unit, the target speed, the mode of operation, the time and date, and a place for the officer to sign the slip. Pressing the MODE switch again can print additional copies of the slip.

If the Falcon HR has the optional DataLogger feature, the locked target speed along with time and date will be stored in the Falcon HR internal nonvolatile memory. The feature can be set to log each time a target speed is locked or when the operator presses the MODE switch while a target is locked. Each locked target can only be logged once; subsequent presses of the MODE switch will not log additional data. This DataLogger can be transferred to a PC and saved in a file to be viewed or printed.

A.1 PRINTER / DATALOGGER OPTIONS

If the Falcon HR has either the Printer or DataLogger feature there will be a maintenance setup screen to select Printer/DataLogger options.

The operator needs to enter the maintenance menu screens on power up. To enter the maintenance menu mode, power the unit off, then press and hold the POWER switch until the power-on sequence stops at the 'Snc' display. Pressing the TEST switch advances the display to the next maintenance screen.

The following is the order of the maintenance screens:

- Snc – Displays speedometer sync number
- CnF – Displays configured features
- SFt – Displays software versions
- Opt – Displays and allows setting options
- PdO – Printer/DataLogger Options
- CLO – Displays and allows setting hour and minute
- CAL – Displays and allows setting month and date
- Yr – Displays and allows setting the year
- UtL – Displays the percentage of memory already used.

To set the Printer/DataLogger options, advance the maintenance screen to 'PdO'. Enter the value of the desired options by pressing the up (RNG) or down (AUD) keys:

- 0 = English, Print and Log Locked Target when MODE pressed.
- 1 = English, Print and Log when Target is Locked.
- 2 = Spanish, Print and Log Locked Target when MODE pressed.
- 3 = Spanish, Print and Log when Target is Locked.

Once the desired value is displayed, press the MODE switch to store these options.

A.2 REAL TIME CLOCK SETUP AND DATA LOGGER MEMORY

The Falcon HR with either the Printer or DataLogger feature will have real time clock circuitry installed in the unit. This clock must be set to the local time and occasionally adjusted to the correct time. The time and date can be set manually by the user or via a PC running the TalonDL software provided by KSI.

To manually set the time and date, the operator needs to enter the maintenance menu screens on power up. To enter the maintenance menu mode, power the unit off, then press and hold the POWER switch until the power-on sequence stops at the 'Snc' display. Pressing the TEST switch advances the display to the next maintenance screen.

To set the time in the Falcon HR, advance the maintenance screen to the 'CLO' display. The current hour will be flashing. To adjust the hour setting, use the down (AUD) or up (RNG) switches. Press the MODE switch to adjust the minute setting. While the minute display is flashing, use the down (AUD) or up (RNG) switch.

Press the TEST switch to advance to the 'CAL' screen. The current month will be flashing. To adjust the month setting, use the down (AUD) or up (RNG) switches. Press the MODE switch to adjust the date setting. While the date display is flashing, use the down (AUD) or up (RNG) switch.

Press the TEST switch to advance to the 'Yr' screen. The current year will be flashing. To adjust the year setting, use the down (AUD) or up (RNG) switch.

Pressing the TEST switch while in the 'Yr' maintenance screen will advance to the DataLogger memory utilized screen 'UtL' if the Falcon HR has DataLogger feature. If the Falcon HR does not have the DataLogger feature, pressing TEST while in the Yr screen will advance the unit to its normal operating mode.

While in the 'UtL' screen, the percentage of memory already used for the DataLogger will be displayed. For example, if UtL and 20 are displayed, 20% of the unit's nonvolatile memory is currently storing data, and 80% is remaining and is available to store data.

NOTE: When the Falcon HR DataLogger memory is completely utilized, new locked target speeds will not be stored until the unit is connected to a PC and the DataLogger is cleared using TalonDL software (provided by KSI).

Pressing the TEST switch while in the 'UtL' maintenance screen will advance the unit to its normal operating mode.

A.3 FALCON HR PRINT OUT

The standard print driver in the Falcon HR is for an Able Systems Ap862-B printer. The Falcon HR is connected to the Able printer using KSI PN# 155-3504-00 cable. The following is an example of the standard print slip:

SN# 1005/ 0130
TARGET 87
PATROL 60
MOV Km/h
14:08 01/15/07

Sign: _____

Line 1—This line displays the internal serial number of the Falcon HR. If the unit has the DataLogger feature, there is a slash and then the number of locks stored in the DataLogger. In the example slip, the unit is serial number 1005, and this is the 130th lock stored in the DataLogger.

Line 2 – This line displays the Locked Target speed.

Line 3 – This line displays the speed of the patrol vehicle at the time of the lock. If the unit was in stationary mode, this line is omitted.

Line 4 – This line displays the mode of operation and unit of measure at the time of the lock.

Line 5 – This line displays the time and date that the lock occurred. The format is Hour:Minute Month/Date/Year.

Line 6 – This line provides a space for the officer to sign or initial the slip.

A.4 FALCON HR DATALOGGER FILE

The officer or supervisor can download the Falcon HR DataLogger memory to a PC file using TalonDL software (provided by KSI). The file will be in a standard text file for viewing or printing. The following is an example of the standard format:

```
Falcon HR SERIAL #: 1005
      04 02 24 09
001 57 04
002 63 12
003 62 38
004 66 54
      04 02 24 10
005 71 02
006 65 12
```

The first line of the file will display the internal serial number of the Falcon HR that stored the DataLogger.

The second line of the file is the first date record line; it shows the year, month, date, and hour of the first series of locks. Each date record line will be indented from the left margin.

The next series of lines are the lock records. Each lock record will show: the number of the lock, the locked target speed, and the minute the lock occurred in the current date record. The third line in the example shows this is the first lock in the DataLogger, the target speed was 57, and it occurred in the 4th minute of the current date record.

A.5 TALONDL PC SOFTWARE

KSI provides TALONDL software to interface with a Falcon HR that has the DataLogger feature. The Falcon HR unit needs to be connected to the PC serial port using a Talon to PC cable KSIPN# 155-3139-00. The TALONDL software allows the operator to:

1. Get the Falcon HR unit's serial number.
2. Get the number of locks stored in the Falcon HR's DataLogger.
3. Get the Falcon HR's internal time and date.
4. Set the time and date in the Falcon HR unit.
5. Download the Falcon HR DataLogger memory.
6. Clear the Falcon HR DataLogger memory.

The TalonDL HELP menu describes the operation of the software.

B. ATTESTATION OF CONFORMITY

B.1 CE CERTIFICATION OF CONFORMITY



SECTION B—ATTESTATION OF CONFORMITY

B.2 AS/NZ CERTIFICATION OF CONFORMITY

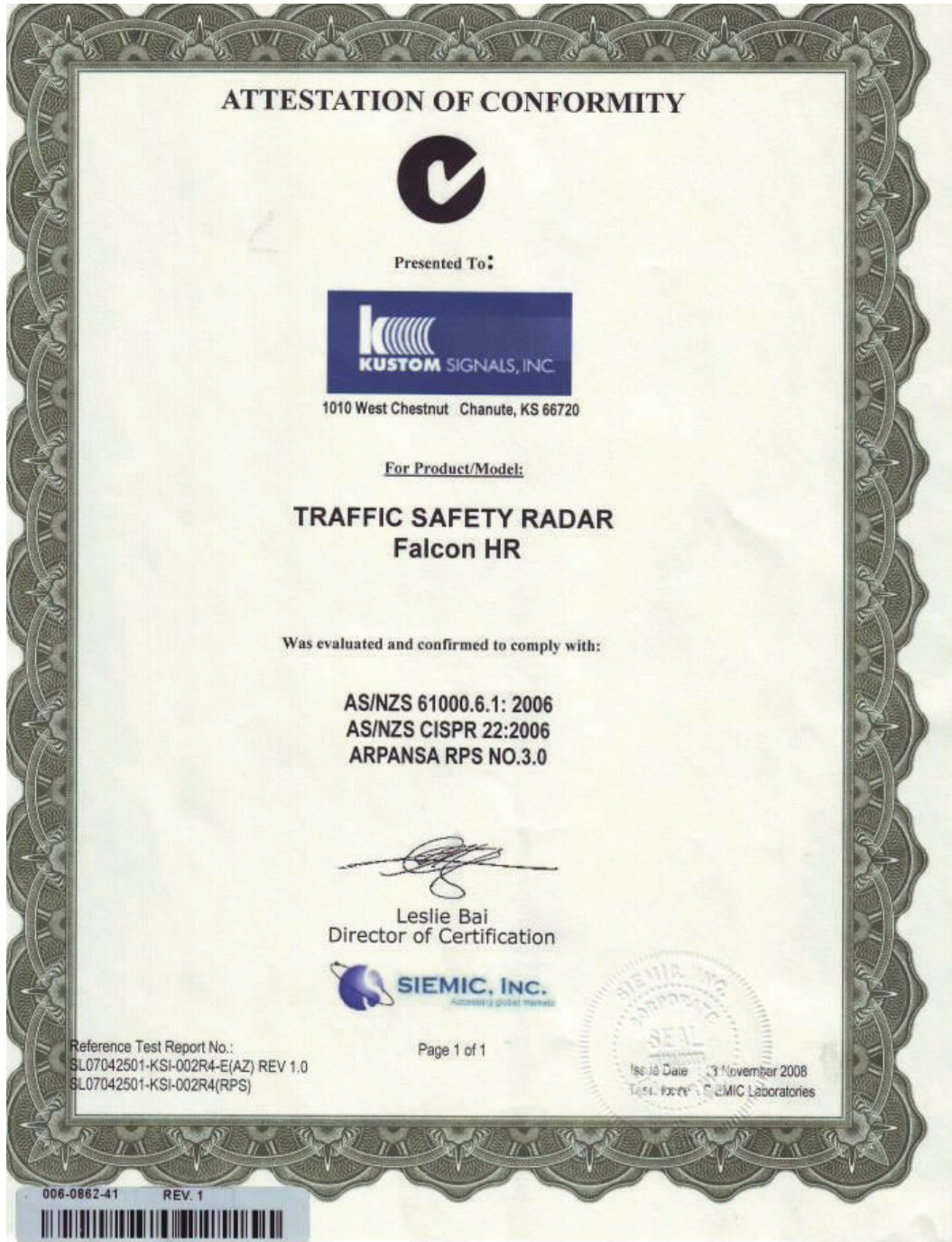

AIRBAG CAUTION

Equipment mounted in 1994 or later series police vehicles may interfere with the operation of passenger side airbags. Information is available directly from the automobile manufacturers regarding areas for safe mounting of equipment such as police radar.

Since this information will vary by vehicle make and model year, Kustom Signals recommends contacting the vehicle manufacturer and following their instructions with respect to mounting of radar units and other equipment.

For additional mounting suggestions, please contact the Kustom Signals Customer Service Department.

Kustom Signals cannot accept any liability for equipment, which has been mounted in conflict with the vehicle manufacturer's recommendation for proper airbag deployment.

PRINTER'S NOTES

- 1. Print Airbag Caution Sheet (located at back of manual) on green bond and insert between pages 3.6 and 4.1 in the manual.**
- 2. Print Section A—Printer / DataLogger Optional Features (front and back) on Buff bond and insert between warranty section and radar log.**
- 3. With-it
Radar Warranty Statement, 006-0979-20**

**DO NOT INCLUDE
THIS SHEET AS
PART OF THE
MANUAL.**

